

# PRICE LIST

# LEUCOS

# 2023

Alle Preise zzgl. ges. MwSt.



## CONTENTS

	P
ALPHABETICAL INDEX/ <i>INDICE ALFABETICO</i>	4
INDEX BY APPLICATION/ <i>INDICE PER APPLICAZIONE</i>	5
TABLE/ <i>TAVOLO</i>	7
FLOOR/ <i>TERRA</i>	19
PENDANT/ <i>SOSPENSIONE</i>	23
WALL/ <i>PARETE</i>	45
CEILING/ <i>SOFFITTO</i>	45
RECESSED/ <i>INCASSO</i>	67
ACCESSORIES/ <i>ACCESSORI</i>	77
GTIN (EAN code)	80
SPECIAL VERSIONS/ <i>VERSIONI SPECIALI</i>	85
TERMS AND CONDITIONS OF SALE/ <i>CONDIZIONI DI VENDITA</i>	86

Price List (VAT excluded) not applicable for north, central, south America  
*Listino prezzi (iva esclusa)*

**ALPHABETICAL INDEX**  
**INDICE ALFABETICO**

	P		P		P
Aella S 54	24 upg	Iside 2 I	69	Planet P-PL 32	62
Aella Mini S 30	25	Keyra P-PL 30	54 upg	Planet P-PL 48	63
Aella T 54	8 upg	Keyra P-PL 60	55	Planet P-PL 65	64
Aella Mini T 30	9	Keyra S 30	36	SD 802 I	72
Alias P 15	46 upg	Keyra S 60	37	SD 803 I	73
Alias P 35	47 upg	Lightbody S	38 new	Sideral I	74
Aurelia S 45	26 new	Lightbody Bold S	39 new	Sphera T3/29	16
Aurelia Bold S 22	27 new	Lightbody T	10 new	Sphera T3/37	17
Beta Small P-PL	48 upg	Lightbody Bold T	11 new	Sphera T3/45	18
Boheme L 8	28	Lilith PL 40	56	Stacking B TR	20
Boheme L 12	29	Lilith PL 55	57	Stacking C TR	21
Celine P	49	Lilith PL 70	58	Stacking D TR	22
Celine P 35	50 upg	Lilith S 40	40	Sun I	75
Cubi P-PL 11	51 upg	Lilith S 55	41	Van 2 I	76
Cubi P-PL 16	52	Lilith S 70	42	Vittoria P 2	65
Cubi P-PL 28	53	Mira 2 I	70	Volta S 120	43
Drop I	68	Paralume Mini T	12	Volta S 160	44
Ether S	30	Paralume P (Small) T	13		
Ether S 90	31	Paralume M (Medium) T	14		
Ether S 150	32	Paralume G (Big) T	15		
Glò INCASSO I	33	Pascale P 40	59		
Glò S	34	Pascale PL 30	60		
Glò S/I	35	Pascale PL 40	61		
		Pegaso I	71		

# INDEX BY APPLICATION

## INDICE PER APPLICAZIONE

<b>TABLE TAVOLO</b>	<b>P</b>	<b>FLOOR TERRA</b>	<b>P</b>	<b>PENDANT SOSPENSIONE</b>	<b>P</b>
Aella T 54	8 upg	Stacking B TR	20	Aella S 54	24 upg
Aella Mini T 30	9	Stacking C TR	21	Aella Mini S 30	25
Lightbody T	10 new	Stacking D TR	22	Aurelia S 45	26 new
Lightbody Bold T	11 new			Aurelia Bold S 22	27 new
Paralume Mini T	12			Boheme L 8	28
Paralume P (Small) T	13			Boheme L 12	29
Paralume M (Medium)T	14			Ether S	30
Paralume G (Big) T	15			Ether S 90	31
Sphera T3/29	16			Ether S 150	32
Sphera T3/37	17			Glò INCASSO I	33
Sphera T3/45	18			Glò S	34
				Glò S/I	35
				Keyra S 30	36
				Keyra S 60	37
				Lightbody S	38 new
				Lightbody Bold S	39 new
				Lilith S 40	40
				Lilith S 55	41
				Lilith S 70	42
				Volta S 120	43
				Volta S 160	44
<b>WALL PARETE</b>	<b>P</b>	<b>CEILING SOFFITTO</b>	<b>P</b>	<b>RECESSED INCASSO</b>	<b>P</b>
Alias P 15	46 upg	Beta Small P-PL	48 upg	Drop I	68
Alias P 35	47 upg	Cubi P-PL 11	51 upg	Iside 2 I	69
Beta Small P-PL	48 upg	Cubi P-PL 16	52	Mira 2 I	70
Celine P	49	Cubi P-PL 28	53	Pegaso I	71
Celine P 35	50 upg	Keyra P-PL 30	54	SD 802 I	72
Cubi P-PL 11	51 upg	Keyra P-PL 60	55 upg	SD 803 I	73
Cubi P-PL 16	52	Lilith PL 40	56	Sideral I	74
Cubi P-PL 28	53	Lilith PL 55	57	Sun I	75
Keyra P-PL 30	54	Lilith PL 70	58	Van 2 I	76
Keyra P-PL 60	55 upg	Pascale PL 30	60		
Pascale P 40	59	Pascale PL 40	61		
Planet P-PL 32	62	Planet P-PL 32	62		
Planet P-PL 48	63	Planet P-PL 48	63		
Planet P-PL 65	64	Planet P-PL 65	64		
Vittoria P 2	65				



EN TABLE

IT TAVOLO

**AELLA T 54 - INDOOR**

Toso &amp; Massari, 1968

upgraded LED and colors

USER REPLACEABLE LED

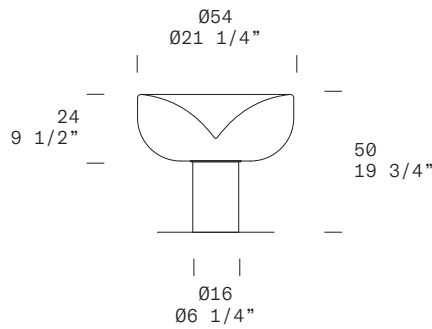

[1]

## TECHNICAL SHEET

MATERIALS	Diffuser: Glass Structure: Brass
DIMENSIONS	Diffuser: Ø54cm h24cm [Ø21 1/4" h9 1/2"] Base: Ø16cm h26cm [Ø6 1/4" h10 1/4"] Cable lenght (E27): 190cm [74 3/4"] Cable lenght (LED): 250cm [98 3/8"]
FINISHES (DIFFUSER + STRUCTURE)	[1] Transparent + Glossy Chrome [2] Transparent + Glossy Warm White [3] Smoke Grey + Matte Gunmetal [4] Transparent + Vintage Brass
	[1] [3] [2] [4]
LIGHT SOURCE	LED 1 x 26,5W LED 3800lm (nominal) 3000K CRI≥90 [E] LED 1 x 26,5W LED 3660lm (nominal) 2700K CRI≥90 [E] E27 1 x 10W Retrofit LED (1 x max 100W Halogen Bulb)
CONTROL	Dimmer on cord
MARKING	DRY LOCATION
PACKAGING	Gross weight: 20,6kg - 0,340m <sup>3</sup> Dimensions: 40,8x40,8x26,2cm + 70x70x60cm
ON REQUEST	other combination colors

## PRICE LIST

CONTROL	Dimmer on cord		
	FINISH	SOURCE	CODE
[1] Transparent + Glossy Chrome	E27**	0012030	1.754,00 €
[2] Transparent + Glossy Warm White	E27**	0012024	1.754,00 €
[3] Smoke Grey + Matte Gunmetal	E27**	0012027	1.864,00 €
[4] Transparent + Vintage Brass	E27**	0012022	1.754,00 €
[1] Transparent + Glossy Chrome	3000K LED 2700K LED	0011573 0011567	2.195,00 €
[2] Transparent + Glossy Warm White	3000K LED 2700K LED	0011542 0011538	2.195,00 €
[3] Smoke Grey + Matte Gunmetal	3000K LED 2700K LED	0011530 0011498	2.305,00 €
[4] Transparent + Vintage Brass	3000K LED 2700K LED	0011524 0011492	2.195,00 €
NOTE	**BULB INCLUDED		





# AELLA MINI T 30 - INDOOR

Toso & Massari, 2017

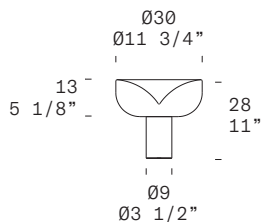

## TECHNICAL SHEET

MATERIALS	Diffuser: Glass Structure: Metal
DIMENSIONS	Diffuser: Ø30cm h13cm [Ø11 3/4" h5 1/8"] Base: Ø9cm h15cm [Ø3 1/2" h5 7/8"] Cable length: 170cm [66 7/8"]
FINISHES (DIFFUSER + STRUCTURE)	[1] Transparent + Glossy Chrome [2] Transparent + Glossy Warm White [3] Smoke Grey + Glossy Gunmetal  
LIGHT SOURCE	LED 1 x 6,1W 762lm (nominal) 2700K CRI≥90 [E]
CONTROL	Dimmer on cord
MARKING	DRY LOCATION
PACKAGING	Gross weight: 6,1kg - 0,060m³ Dimensions: 38x38x40cm



## PRICE LIST

CONTROL	Dimmer on cord			
	FINISH	SOURCE	CODE	UNIT PRICE vat excluded
	[1] Transparent + Glossy Chrome	2700K LED	0008713	541,00 €
	[2] Transparent + Glossy Warm White	2700K LED	0012197	541,00 €
	[3] Smoke Grey + Glossy Gunmetal	2700K LED	0008913	574,00 €
NOTE	*ALL PRICES ARE VAT EXCLUDED			

**LIGHTBODY T - INDOOR**

Jörg Hugo, 2021

new



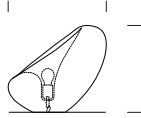

Ø31-35  
Ø12 1/4"-13 3/4"



31-35  
12 1/4"-13 3/4"



## TECHNICAL SHEET

MATERIALS	Diffuser: Glass Structure: Metal
DIMENSIONS	Diffuser: ø31-35cm h31-35cm [ø12 1/4"-13 3/4" h12 1/4"-13 3/4"] Cable length: 200cm [78 3/4"]
FINISHES (DIFFUSER + STRUCTURE)	Transparent + Matte Black 
LIGHT SOURCE	E27 1 x 10W Retrofit LED (1 x max 43W Halogen Bulb)
CONTROL	On-off or dimmer on cord
MARKING	DRY LOCATION   
PACKAGING	Gross weight: 5kg - 0,06m³ Dimensions: 43,5x43,5x35cm

## PRICE LIST

CONTROL	On-off		
FINISH	SOURCE	CODE	UNIT PRICE vat excluded
Transparent + Matte Black	E27	0012195	590,00 €
CONTROL	Dimmer on cord*		
FINISH	SOURCE	CODE	UNIT PRICE vat excluded
Transparent + Matte Black	E27	0012196	682,00 €
NOTE	*BULB INCLUDED		



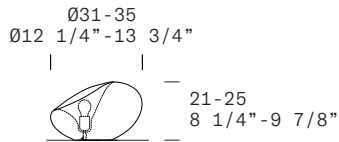

# LIGHTBODY BOLD T - INDOOR

Jörg Hugo, 2021

new



## TECHNICAL SHEET

MATERIALS	Diffuser: Glass Structure: Metal
DIMENSIONS	Diffuser: Ø31-35cm h21-25cm [Ø12 1/4"-13 3/4" h8 1/4"-9 7/8"] Cable length: 200cm [78 3/4"]
FINISHES (DIFFUSER + STRUCTURE)	Transparent + Matte Black 
LIGHT SOURCE	E27 1 x 10W Retrofit LED (1 x max 43W Halogen Bulb)
CONTROL	On-off or dimmer on cord
MARKING	DRY LOCATION   
PACKAGING	Gross weight: 4,5kg - 0,06m <sup>3</sup> Dimensions: 43,5x43,5x35cm

Front view



## PRICE LIST



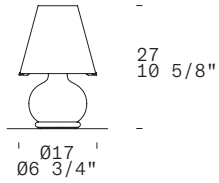

CONTROL	On-off		
FINISH	SOURCE	CODE	UNIT PRICE vat excluded
Transparent + Matte Black	E27	0011516	567,00 €
CONTROL	Dimmer on cord*		
FINISH	SOURCE	CODE	UNIT PRICE vat excluded
Transparent + Matte Black	E27	0011517	659,00 €
NOTE	*BULB INCLUDED		

**PARALUME MINI T - INDOOR**

Leucos Design Lab, 2004

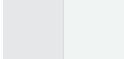

## TECHNICAL SHEET

MATERIALS	Diffuser: Blown and Layered Glass Structure: Metal
DIMENSIONS	Diffuser: $\varnothing 17\text{cm}$ h27cm [ $\varnothing 3\ 3/4''$ h10 5/8"] Cable length: 180cm [70 7/8"]
FINISHES (DIFFUSER + STRUCTURE)	Satin White + White 
LIGHT SOURCE	E14 1 x 5W Retrofit LED (1 x max 46W Halogen Bulb) + G9 1 x 3W Retrofit LED (1 x max 20W Halogen Bulb)
CONTROL	Double Light Switch
MARKING	DRY LOCATION   
PACKAGING	Gross weight: 1,8kg - 0,04m <sup>3</sup> Dimensions: 40x40x20cm

Double Light Switch



## PRICE LIST



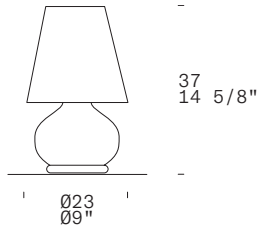

CONTROL		Double Light Switch	
FINISH	SOURCE	CODE	UNIT PRICE (vat excluded)
Satin White + White	E14 + G9	0002524	428,00 €

**PARALUME P (SMALL) T - INDOOR**

Leucos Design Lab, 1983

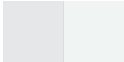

**TECHNICAL SHEET**

<b>MATERIALS</b>	Diffuser: Blown and Layered Glass Structure: Metal
<b>DIMENSIONS</b>	Diffuser: Ø23cm h37cm [Ø9" h14" 5/8"] Cable lenght: 180cm [70 7/8"]
<b>FINISHES (DIFFUSER + STRUCTURE)</b>	Satin White + White 
<b>LIGHT SOURCE</b>	E14 1 x 5W Retrofit LED (1 x max 46W Halogen Bulb) + E14 1 x 5W Retrofit LED (1 x max 30W Halogen Bulb)
<b>MARKING</b>	DRY LOCATION   
<b>PACKAGING</b>	Gross weight: 3kg - 0,05m³ Dimensions: 40,8x40,8x26,2cm

Double Light Switch



**PRICE LIST**



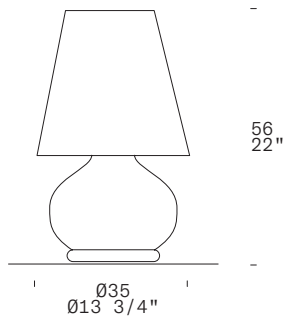

<b>CONTROL</b>		<b>Double Light Switch</b>	
<b>FINISH</b>	<b>SOURCE</b>	<b>CODE</b>	<b>UNIT PRICE (vat excluded)</b>
Satin White + White	E14	0002523	477,00 €

**PARALUME M (MEDIUM) T - INDOOR**

Leucos Design Lab, 1983

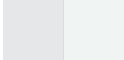

## TECHNICAL SHEET

MATERIALS	Diffuser: Blown and Layered Glass Structure: Metal
DIMENSIONS	Diffuser: $\varnothing 35\text{cm}$ h56cm [ $\varnothing 13\ 3/4''$ h22"] Cable length: 180cm [ $70\ 7/8''$ ]
FINISHES (DIFFUSER + STRUCTURE)	Satin White + White 
LIGHT SOURCE	E27 1 x 10W Retrofit LED (1 x max 77W Halogen Bulb) + E27 1 x 10W Retrofit LED (1 x max 46W Halogen Bulb)
CONTROL	Double Light Switch
MARKING	DRY LOCATION   
PACKAGING	Gross weight: 8,7kg - 0,13m <sup>3</sup> Dimensions: 43,5x43,5x35cm (2 boxes)

Double Light Switch



## PRICE LIST



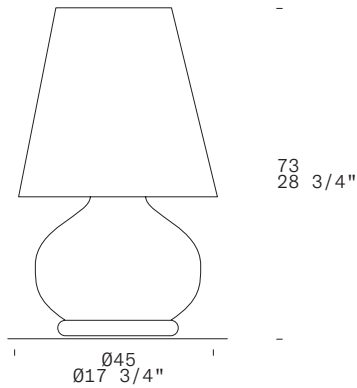

CONTROL	Double Light Switch		
FINISH	SOURCE	CODE	UNIT PRICE vat excluded
Satin White + White	E27	0002516	705,00 €

**PARALUME G (BIG) T - INDOOR**

Leucos Design Lab, 1983



TECHNICAL SHEET

MATERIALS	Diffuser: Blown and Layered Glass Structure: Metal
DIMENSIONS	Diffuser: Ø45cm h73cm [Ø45" h28 3/4"] Cable length: 180cm [70 7/8"]
FINISHES (DIFFUSER + STRUCTURE)	Satin White + White 
LIGHT SOURCE	E27 2 x 10W Retrofit LED (2 x max 77W Halogen Bulb)
MARKING	DRY LOCATION   
PACKAGING	Gross weight: 13,4kg - 0,25m³ Dimensions: 50x50x50cm (2 boxes)

Double Light Switch



PRICE LIST



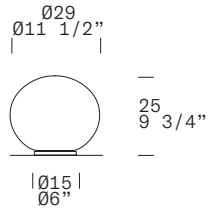

CONTROL	Double Light Switch		
FINISH	SOURCE	CODE	UNIT PRICE vat excluded
Satin White + White	E27	0002514	1.192,00 €

**SPHERA T3/29 - INDOOR**

Matteo Thun, 2000



## TECHNICAL SHEET

MATERIALS	Diffuser: Blown Glass Structure: Metal
DIMENSIONS	Diffuser: $\varnothing$ 29cm h25cm [ $\varnothing$ 11 1/2" h9 3/4"] Cable length: 180cm [70 7/8"]
FINISHES (DIFFUSER + STRUCTURE)	[1] Satin White + Chrome [2] Satin White + Brushed Brass  [1]  [2]
LIGHT SOURCE	E27 1 x 15W Retrofit LED (1 x max 100W Halogen Bulb)
CONTROL	On-Off
MARKING	DRY LOCATION   
PACKAGING	Gross weight: 3,9kg - 0,007m <sup>3</sup> Dimensions: 45x35x45cm



## PRICE LIST

CONTROL	On-off			
	FINISH	SOURCE	CODE	UNIT PRICE vat excluded
	Satin White + Chrome	E27	0004078	278,00 €
	Satin White + Brushed Brass	E27	0011058	296,00 €







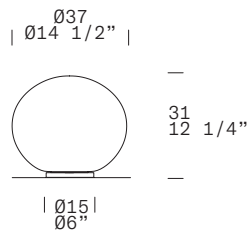

**SPHERA T3/37 - INDOOR**

Matteo Thun, 2000

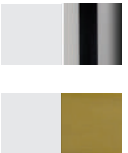

TECHNICAL SHEET

MATERIALS	Diffuser: Blown Glass Structure: Metal
DIMENSIONS	Diffuser: $\varnothing 37$ cm h31cm [ $\varnothing 14 \frac{1}{2}$ " h12 $\frac{1}{4}$ "] Cable length: 180cm [70 $\frac{7}{8}$ "]
FINISHES (DIFFUSER + STRUCTURE)	[1] Satin White + Chrome [2] Satin White + Brushed Brass 
LIGHT SOURCE	E27 1 x 15W Retrofit LED (1 x max 150W Halogen Bulb)
CONTROL	Dimmer on cord
MARKING	DRY LOCATION   
PACKAGING	Gross weight: 6,1kg - 0,15m <sup>3</sup> Dimensions: 52x52x54cm



PRICE LIST

CONTROL	Dimmer on cord			
	FINISH	SOURCE	CODE	UNIT PRICE vat excluded
	Satin White + Chrome	E27	0004081	339,00 €
	Satin White + Brushed Brass	E27	0011059	363,00 €





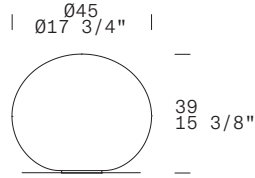

**SPHERA T3/45 - INDOOR**

Matteo Thun, 2000



## TECHNICAL SHEET

MATERIALS	Diffuser: Blown Glass Structure: Metal
DIMENSIONS	Diffuser: ø45cm h39cm [ø17 3/4" h15 3/8"] Cable lenght: 180cm [70 7/8"]
FINISHES (DIFFUSER + STRUCTURE)	[1] Satin White + Chrome [2] Satin White + Brushed Brass  [1]  [2]
LIGHT SOURCE	E27 1 x 15W Retrofit LED (1 x max 150W Halogen Bulb)
CONTROL	Dimmer on cord
MARKING	DRY LOCATION   
PACKAGING	Gross weight: 7,4kg - 0,125m <sup>3</sup> Dimensions: 50x50x50cm



## PRICE LIST

CONTROL	Dimmer on cord			
	FINISH	SOURCE	CODE	UNIT PRICE vat excluded
	Satin White + Chrome	E27	0004062	460,00 €
	Satin White + Brushed Brass	E27	0011060	484,00 €



EN FLOOR

IT TERRA

**STACKING B TR - INDOOR**

Rockwell Group, 2007

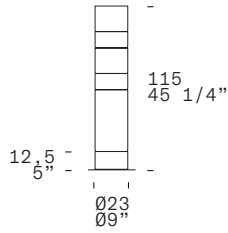

**TECHNICAL SHEET**

<b>MATERIALS</b>	Diffuser: Blown Glass Structure: Metal
<b>DIMENSIONS</b>	Diffuser: Ø23cm h115cm [Ø9" h45 1/4"] Cable length: 220cm [86 5/8"]
<b>FINISHES (DIFFUSER + STRUCTURE)</b>	Smoke Grey, White, Smoke Grey, White, Mirror + Chrome 
<b>LIGHT SOURCE</b>	GU10 4 x 7W Retrofit LED (4 x max 50W Halogen Bulb)
<b>CONTROL</b>	Dimmer on cord
<b>MARKING</b>	DRY LOCATION   
<b>PACKAGING</b>	Gross weight: 29,1kg - 0,46m³ -Structure Dimensions: 38x38x35cm -Diffusers Dimensions: 38x38x35cm (2 boxes) 38x38x53cm (2 boxes) 73x42x42cm (1 box)

**PRICE LIST**

<b>CONTROL</b>	<b>Dimmer on cord</b>		
<b>FINISH</b>	<b>SOURCE</b>	<b>CODE</b>	<b>UNIT PRICE vat excluded</b>
Smoke Grey, White, Smoke Grey, White, Mirror + Chrome	GU10	0004096	3.016,00 €

# STACKING C TR - INDOOR

Rockwell Group, 2007

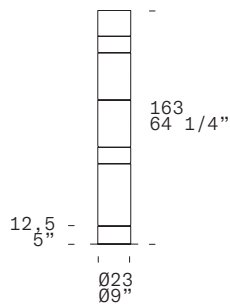

## TECHNICAL SHEET

MATERIALS	Diffuser: Blown Glass Structure: Metal
DIMENSIONS	Diffuser: Ø23cm h163cm [Ø9" h64 1/4"] Cable length: 220cm [86 5/8"]
FINISHES (DIFFUSER + STRUCTURE)	Smoke Grey, White, Amber, Tobacco, White, Amber + Gold 
LIGHT SOURCE	GU10 4 x 7W Retrofit LED (4 x max 50W Halogen Bulb)
CONTROL	Dimmer on cord
MARKING	DRY LOCATION   
PACKAGING	Gross weight: 33,3kg - 0,58m³ -Structure Dimensions: 38x38x35cm -Diffusers Dimensions: 38x38x35cm (2 boxes) 38x38x53cm (1 box) 41,2x41,2x58 (2 boxes) 73x42x42cm (1 box)



## PRICE LIST



CONTROL	Dimmer on cord		
FINISH	SOURCE	CODE	UNIT PRICE vat excluded
Smoke Grey, White, Amber, Tobacco, White, Amber + Gold	GU10	0004098	3.407,00 €

**STACKING D TR - INDOOR**

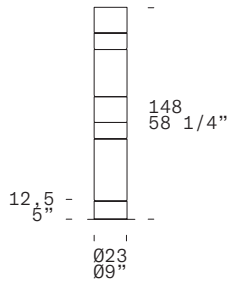
Rockwell Group, 2007



**TECHNICAL SHEET**

<b>MATERIALS</b>	Diffuser: Blown Glass Structure: Metal
<b>DIMENSIONS</b>	Diffuser: Ø23cm h148cm [Ø9" h58 1/4"] Cable lenght: 220cm [86 5/8"]
<b>FINISHES (DIFFUSER + STRUCTURE)</b>	White, Gold, Transparent Tobacco, White, Gold, Black + Gold 
<b>LIGHT SOURCE</b>	GU10 4 X 7W Retrofit LED (4 x max 50W Halogen Bulb)
<b>CONTROL</b>	Dimmer on cord
<b>MARKING</b>	DRY LOCATION   
<b>PACKAGING</b>	Gross weight: 31,9kg - 0,56m³ -Structure Dimensions: 38x38x35cm -Diffusers Dimensions: 38x38x35cm (2 boxes) 38x38x53cm (2 boxes) 41,2x41,2x58 (1 box) 73x42x42cm (1 box)



**PRICE LIST**

<b>CONTROL</b>		<b>Dimmer on cord</b>	
<b>FINISH</b>	<b>SOURCE</b>	<b>CODE</b>	<b>UNIT PRICE vat excluded</b>
White, Gold, Transparent Tobacco, White, Gold, Black + Gold	GU10	0004100	3.896,00 €

EN PENDANT

IT SOSPENSIONE

**AELLA S 54 - INDOOR**

Toso & Massari, 2016

USER REPLACEABLE LED

upgraded LED and colors

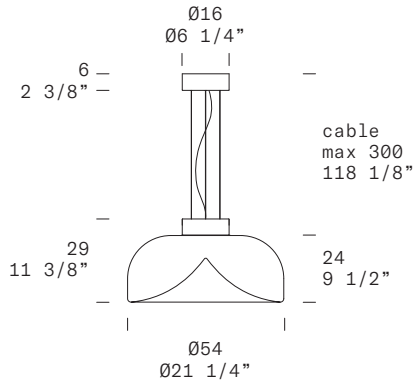

TECHNICAL SHEET

MATERIALS	Diffuser: Glass Structure: Brass
DIMENSIONS	Diffuser: Ø54cm h24cm [Ø21 1/4" h9 1/2"] Canopy: Ø16cm h6cm [Ø6 1/4" h2 3/8"] Cable: 300cm [118 1/8"]
FINISHES (DIFFUSER + STRUCTURE)	[1] Transparent + Glossy Chrome [2] Transparent + Glossy Warm White [3] Smoke Grey + Matte Gunmetal [4] Transparent + Vintage Brass
LIGHT SOURCE	LED 1 x 26,5W LED 3800lm (nominal) 3000K CRI≥90 [E] LED 1 x 26,5W LED 3660lm (nominal) 2700K CRI≥90 [E]
CONTROL	Phase-cut Push-dim; 0/1-10V, DALI
MARKING	DRY LOCATION
PACKAGING	Gross weight: 14,9kg - 0,290m³ Dimensions: 70x70x60cm
ON REQUEST	other combination colors

PRICE LIST

CONTROL	Push-dim; 0/1-10V, DALI		
FINISH	SOURCE	CODE	UNIT PRICE vat excluded
[1] Transparent + Glossy Chrome	3000K LED 2700K LED	0011532 0011500	1.644,00 €
[2] Transparent + Glossy Warm White	3000K LED 2700K LED	0011565 0011559	1.644,00 €
[3] Smoke Grey + Matte Gunmetal	3000K LED 2700K LED	0012000 0012006	1.754,00 €
[4] Transparent + Vintage Brass	3000K LED 2700K LED	0011561 0011555	1.644,00 €

CONTROL	Phase-cut		
FINISH	SOURCE	CODE	UNIT PRICE vat excluded
[1] Transparent + Glossy Chrome	3000K LED 2700K LED	0012187 0012191	1.644,00 €
[2] Transparent + Glossy Warm White	3000K LED 2700K LED	0012188 0012192	1.644,00 €
[3] Smoke Grey + Matte Gunmetal	3000K LED 2700K LED	0012190 0012194	1.754,00 €
[4] Transparent + Vintage Brass	3000K LED 2700K LED	0012202 0012201	1.644,00 €







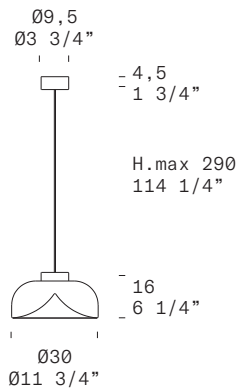

# AELLA MINI S 30 - INDOOR

Toso & Massari, 2017



## TECHNICAL SHEET

MATERIALS	Diffuser: Glass Structure: Metal
DIMENSIONS	Diffuser: 030cm h16cm [011 3/4" h6 1/4"] Canopy: 09,5cm h4,5cm [03 3/4" h1 3/4"] Cable: 290cm [114 1/4"]
FINISHES (DIFFUSER + STRUCTURE)	[1] Transparent + Glossy Chrome [2] Transparent + Glossy Warm White [3] Smoke Grey + Glossy Gunmetal  
LIGHT SOURCE	LED 1 x 4,2W 564lm (nominal) 2700K CRI≥90 [E]
CONTROL	Phase-cut
MARKING	DRY LOCATION   
PACKAGING	Gross weight: 4,4kg - 0,060m <sup>3</sup> Dimensions: 38x38x40cm

## PRICE LIST

CONTROL	Phase-cut		
	FINISH	SOURCE	CODE
[1] Transparent + Glossy Chrome	2700K LED	0008879	541,00 €
[2] Transparent + Glossy Warm White	2700K LED	0012199	541,00 €
[3] Smoke Grey + Glossy Gunmetal	2700K LED	0008939	574,00 €
ACCESSORIES	COLOR	CODE	UNIT PRICE vat excluded
Off centre kit 3	chrome gold	8000152 8000137	20,00 € 20,00 €



**AURELIA S 45 - INDOOR**

Patrick Jouin, 2021

USER REPLACEABLE LED



new

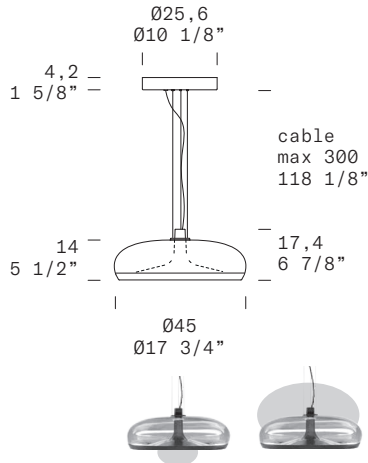

TECHNICAL SHEET

**MATERIALS** Diffuser: Glass  
Structure: Metal

**DIMENSIONS** Diffuser: Ø45cm h14cm [Ø17 3/4" h5 1/2"]  
Canopy: Ø25,6cm h4,2cm [Ø10 1/8" h1 5/8"]  
Cable lenght: 300cm [118 1/8"]

**FINISHES (DIFFUSER + STRUCTURE)**  
[1] Trasparent + Matte Gunmetal  
[2] Trasparent + Vintage Brass  
[3] Trasparent + Glossy Warm White  
[4] Smoke Grey + Matte Gunmetal  
[5] Smoke Grey + Vintage Brass  
[6] Smoke Grey + Glossy Warm White

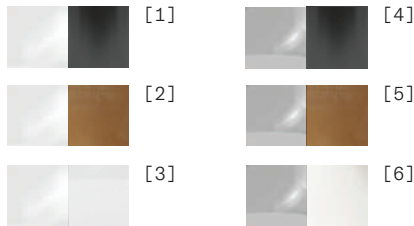

**LIGHT SOURCE**  
Single or double switch and dimming  
Direct: LED 1 x 11,6W 1531lm (nominal)  
3000K CRI≥90 [E]  
Indirect: LED 1 x 18W 1960lm (nominal)  
3000K CRI≥90 [F]  
or  
Direct: LED 1 x 11,6W 1471lm (nominal)  
2700K CRI≥90 [E]  
Indirect: LED 1 x 18W 1700lm (nominal)  
2700K CRI≥90 [F]

**CONTROL** Push-dim; 0/1-10V  
Phase cut

**MARKING** DRY LOCATION

**PACKAGING** Gross weight: 10,2kg - 0,180m³  
Dimensions: 56x56x28cm (2 boxes)

**ON REQUEST** Dimmer DALI



PRICE LIST

CONTROL		Push-dim; 0/1-10V	
FINISH	SOURCE	CODE	UNIT PRICE vat excluded
[1] Trasparent + Matte Gunmetal	3000K LED	0011468	1.463,00 €
	2700K LED	0011481	
[2] Trasparent + Vintage Brass	3000K LED	0011467	1.463,00 €
	2700K LED	0011479	
[3] Trasparent + Glossy Warm White	3000K LED	0011469	1.350,00 €
	2700K LED	0011483	
[4] Smoke Grey + Matte Gunmetal	3000K LED	0011474	1.463,00 €
	2700K LED	0011487	
[5] Smoke Grey + Vintage Brass	3000K LED	0011473	1.463,00 €
	2700K LED	0011485	
[6] Smoke Grey + Glossy Warm White	3000K LED	0011475	1.350,00 €
	2700K LED	0011489	

CONTROL		Phase-cut	
FINISH	SOURCE	CODE	UNIT PRICE vat excluded
[1] Trasparent + Matte Gunmetal	3000K LED	0012043	1.565,00 €
	2700K LED	0012049	
[2] Trasparent + Vintage Brass	3000K LED	0012042	1.565,00 €
	2700K LED	0012048	
[3] Trasparent + Glossy Warm White	3000K LED	0012044	1.452,00 €
	2700K LED	0012050	
[4] Smoke Grey + Matte Gunmetal	3000K LED	0012046	1.565,00 €
	2700K LED	0012052	
[5] Smoke Grey + Vintage Brass	3000K LED	0012045	1.565,00 €
	2700K LED	0012051	
[6] Smoke Grey + Glossy Warm White	3000K LED	0012047	1.452,00 €
	2700K LED	0012053	

# AURELIA BOLD S 22 - INDOOR

Patrick Jouin, 2021

USER REPLACEABLE LED



new

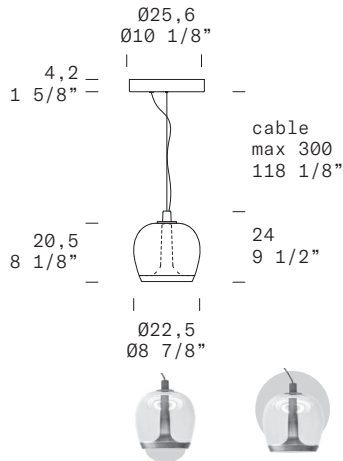

## TECHNICAL SHEET

**MATERIALS** Diffuser: Glass  
Structure: Metal

**DIMENSIONS** Diffuser: Ø22,5 h20,5 (Ø8 7/8 h 8 1/8)  
Canopy: Ø25,5cm h4,2cm [Ø10 1/8" h1 5/8"]  
Cable lenght: 300cm [118 1/8"]

**FINISHES (DIFFUSER + STRUCTURE)**  
[1] Trasparent + Matte Gunmetal  
[2] Trasparent + Vintage Brass  
[3] Trasparent + Glossy Warm White  
[4] Smoke Grey + Matte Gunmetal  
[5] Smoke Grey + Vintage Brass  
[6] Smoke Grey + Glossy Warm White

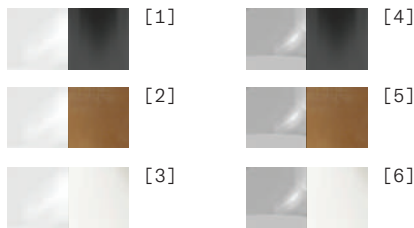

**LIGHT SOURCE**  
Single or double switch and dimming  
Direct: LED 1 x 11,6W 1531lm (nominal) 3000K CRI≥90 [E]  
Indirect: LED 1 X 7,2W 784lm (nominal) 3000K CRI≥90 [F]  
or  
Direct: LED 1 x 11,6W 1471lm (nominal) 2700K CRI≥90 [E]  
Indirect: LED 1 X 7,2W 768lm (nominal) 2700K CRI≥90 [F]

**CONTROL** Push-dim; 0/1-10V  
Phase cut

**MARKING** DRY LOCATION

**PACKAGING** Gross weight: 5,6kg - 0,06m³  
Dimensions: 43,5x43,5x35cm

**ON REQUEST** Dimmer DALI

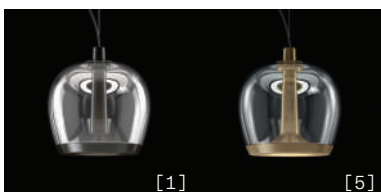

## PRICE LIST

CONTROL		Push-dim; 0/1-10V	
FINISH	SOURCE	CODE	UNIT PRICE vat excluded
[1] Trasparent + Matte Gunmetal	3000K LED	0011493	982,00 €
	2700K LED	0011505	
[2] Trasparent + Vintage Brass	3000K LED	0011491	982,00 €
	2700K LED	0011503	
[3] Trasparent + Glossy Warm White	3000K LED	0011495	938,00 €
	2700K LED	0011507	
[4] Smoke Grey + Matte Gunmetal	3000K LED	0011499	982,00 €
	2700K LED	0011511	
[5] Smoke Grey + Vintage Brass	3000K LED	0011497	982,00 €
	2700K LED	0011509	
[6] Smoke Grey + Glossy Warm White	3000K LED	0011501	938,00 €
	2700K LED	0011513	



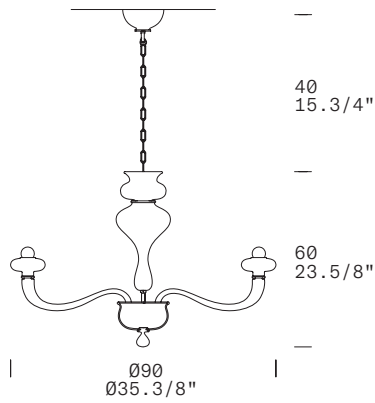

CONTROL		Phase-cut	
FINISH	SOURCE	CODE	UNIT PRICE vat excluded
[1] Trasparent + Matte Gunmetal	3000K LED	0012055	1.080,00 €
	2700K LED	0012061	
[2] Trasparent + Vintage Brass	3000K LED	0012054	1.080,00 €
	2700K LED	0012060	
[3] Trasparent + Glossy Warm White	3000K LED	0012056	1.036,00 €
	2700K LED	0012062	
[4] Smoke Grey + Matte Gunmetal	3000K LED	0012058	1.080,00 €
	2700K LED	0012064	
[5] Smoke Grey + Vintage Brass	3000K LED	0012057	1.080,00 €
	2700K LED	0012063	
[6] Smoke Grey + Glossy Warm White	3000K LED	0012059	1.036,00 €
	2700K LED	0012065	

## BOHEME L 8 - INDOOR

Oriano Favaretto, 2015

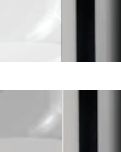

### TECHNICAL SHEET

MATERIALS	Diffuser: Blown Glass Structure: Metal
DIMENSIONS	Diffuser: ø90cm h60cm [ø35 3/8" h23 5/8"]
FINISHES (DIFFUSER + STRUCTURE)	[1] Trasparent + Chrome [2] Smoke Grey + Chrome 
LIGHT SOURCE	E14 8 x 5W Retrofit LED (8 x max 48W Halogen Bulb)
MARKING	DRY LOCATION   
PACKAGING	Gross weight: 17,6kg - 0,023m³ Dimensions: 71x53,5x30cm (2 boxes)
NOTE	Free supplied chromed metal chain for extension (45cm - 17 3/4")



### PRICE LIST

FINISH	SOURCE	CODE	UNIT PRICE vat excluded
[1] Trasparent + Chrome	E14	0000781	on request
[2] Smoke Grey + Chrome	E14	0000782	on request

  

ACCESSORIES	L	CODE	UNIT PRICE*
Chromed chain to extended	100 cm - 39 3/8"	8000027	40,00 €





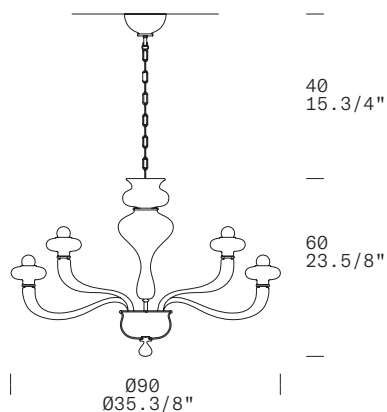

# BOHEME L 12 - INDOOR

Oriano Favaretto, 2015

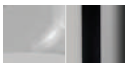

## TECHNICAL SHEET

MATERIALS	Diffuser: Blown Glass Structure: Metal
DIMENSIONS	Diffuser: ø90cm h60cm [ø35 3/8" h23 5/8"]
FINISHES (DIFFUSER + STRUCTURE)	[1] Trasparent + Chrome [2] Smoke Grey + Chrome  [1]  [2]
LIGHT SOURCE	E14 12 x 5W Retrofit LED (12 x max 48W Halogen Bulb)
MARKING	DRY LOCATION   
PACKAGING	Gross weight: 40kg - 0,23m³ Dimensions: 71x53,5x20cm
NOTE	Free supplied chromed metal chain for extension (45cm - 17 3/4")

## PRICE LIST

FINISH	SOURCE	CODE	UNIT PRICE vat excluded
[1] Trasparent + Chrome	E14	0000784	on request
[2] Smoke Grey + Chrome	E14	0000785	on request
ACCESSORIES	L	CODE	UNIT PRICE vat excluded
Chromed chain to extended	100 cm - 39 3/8"	8000027	40,00 €



**ETHER S - INDOOR**

Patrick Jouin, 2007

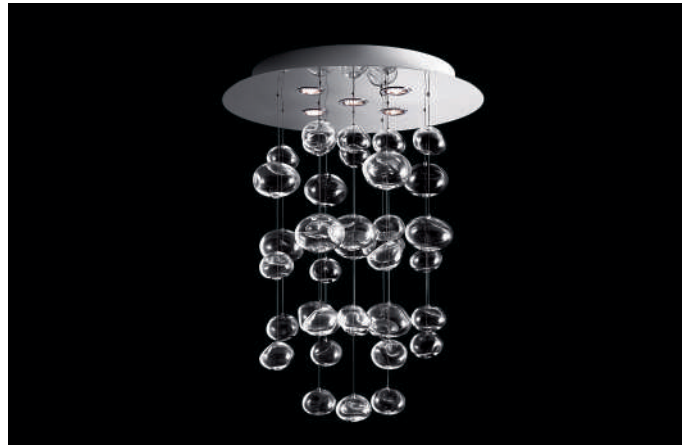
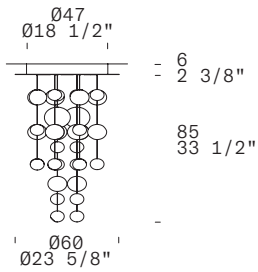

TECHNICAL SHEET

MATERIALS	Diffuser: Handmade Borosilicate Blown Glass Structure: Steel
DIMENSIONS	Diffuser: Ø60cm h85cm [Ø23 5/8" h33 1/2"] Canopy: Ø47cm h6cm [Ø18 1/2" h2 3/8"]
FINISHES (DIFFUSER + STRUCTURE)	Transparent + Polished Steel 
LIGHT SOURCE	GU10 5 x 7W Retrofit LED
MARKING	DRY LOCATION   
PACKAGING	Gross weight: 29,9kg - 0,82m³ Dimensions: 70x70x25cm (box structure) 50,2x23,7x21cm (box diffusers) Shipment: 1 pallet 120x80x70cm
ON REQUEST	Special Versions (see p.85)

PRICE LIST

FINISH	SOURCE	CODE	UNIT PRICE vat excluded
Transparent + Polished Steel	GU10	0010070	2.376,00 €

Special version

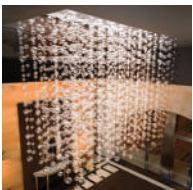



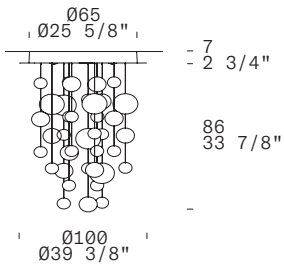

**ETHER S 90 - INDOOR**

Patrick Jouin, 2006



**TECHNICAL SHEET**

<b>MATERIALS</b>	Diffuser: Handmade Borosilicate Blown Glass Structure: Steel
<b>DIMENSIONS</b>	Diffuser: Ø100cm h86cm [Ø39 3/8" h33" 7/8"] Canopy: Ø65cm h7cm [Ø25 5/8" h2 3/4"]
<b>FINISHES (DIFFUSER + STRUCTURE)</b>	Transparent + Polished Steel 
<b>LIGHT SOURCE</b>	G53 4 x 15W Retrofit LED G53 4 x 15W Retrofit LED + GU5,3 1 X 8W Retrofit LED RGB 660lm
<b>MARKING</b>	DRY LOCATION   
<b>PACKAGING</b>	Gross weight: 46,6kg - 1,04m³ Dimensions: 120x120x15cm (box structure) 50,2x23,7x21cm (box diffusers) Shipment: 1 pallet 120x120x72cm
<b>ON REQUEST</b>	Special Versions (see p.85)

RGB LED version    Special version

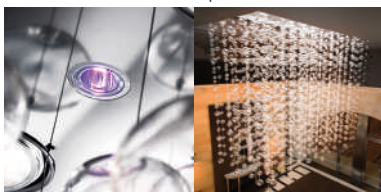

**PRICE LIST**



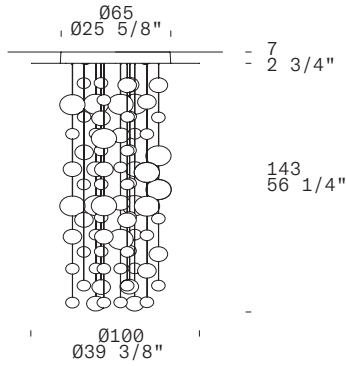

FINISH	SOURCE	CODE	UNIT PRICE vat excluded
Transparent + Polished Steel	G53	0010064	4.068,00 €
Transparent + Polished Steel	G53 + GU5,3*	0010065	4.464,00 €
<b>NOTE</b>	* GU5,3 LED WITH RGB + REMOTE CONTROL (USABLE UNTIL 5M)		

## ETHER S 150 - INDOOR

Patrick Jouin, 2006



### TECHNICAL SHEET

MATERIALS	Diffuser: Handmade Borosilicate Blown Glass Structure: Steel	
DIMENSIONS	Diffuser: Ø100cm h143cm [Ø39 3/8" h56" 1/4"] Canopy: Ø65cm h7cm [Ø25 5/8" h2 3/4"]	
FINISHES (DIFFUSER + STRUCTURE)	Transparent + Polished Steel 	
LIGHT SOURCE	G53 4 x 15W Retrofit LED G53 4 x 15W Retrofit LED + GU5,3 1 x 8W Retrofit LED RGB 6601m	
MARKING	DRY LOCATION   	
PACKAGING	Gross weight: 54,3kg - 1,95m <sup>3</sup> Dimensions: 120x120x15cm (box structure) 84,2x23,7x21cm (box diffusers) Shipment: 1 pallet 120x120x120cm	
ON REQUEST	Special Versions (see p.85)	

### PRICE LIST

FINISH	SOURCE	CODE	UNIT PRICE vat excluded
Transparent + Polished Steel	G53	0010060	5.855,00 €
Transparent + Polished Steel	G53 + GU5,3*	0010061	6.353,00 €
NOTE	* GU5,3 LED WITH RGB + REMOTE CONTROL (USABLE UNTIL 5M)		

RGB LED version Special version

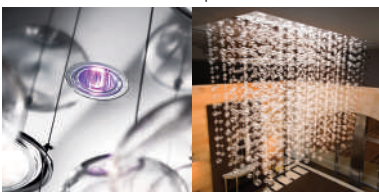



# GLÒ INCASSO I - INDOOR

Danilo De Rossi, 2002

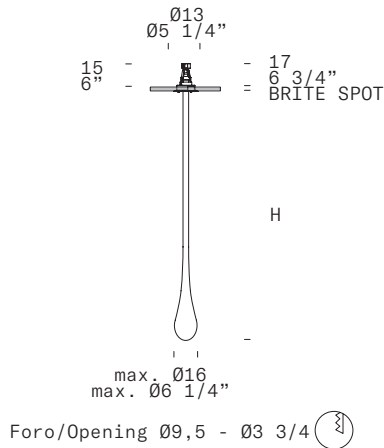

## TECHNICAL SHEET

MATERIALS	Diffuser: Blown Glass Structure: Metal
DIMENSIONS	Diffuser: h85cm [h33 1/2"] h150cm [h59"] h210cm [h82 5/8"] h270cm [h106 1/4"]
FINISHES (DIFFUSER + STRUCTURE)	[1] White Sfumato + Chrome [2] Red + Chrome [3] Acquamarine + Chrome
	[1] [2] [3]
LIGHT SOURCE	GU10 1 x 7W Retrofit LED (1 x max 50W Halogen Bulb)
MARKING	DRY LOCATION
PACKAGING	-Structure Gross weight: 1kg - 0,013m³ Dimensions: 20x32x21cm -Diffuser h85cm [h33 1/2"] Gross weight: 11kg - 0,19m³ Dimensions: 132x37x37,4cm -Diffuser h150cm [h59"] Gross weight: 11,2kg - 0,16m³ Dimensions: 170x30x30cm -Diffuser h210cm [h82 5/8"] Gross weight: 25kg - 0,49m³ Dimensions: 282x40x43cm -Diffuser h270cm [h106 1/4"] Gross weight: 31,2kg - 0,58m³ Dimensions: 33,2x40x43cm
NOTE	The weight can be according to the thickness of the glass. The size of the drop diameter varies in proportion to the product height (max Ø16cm Ø6 1/4"). Custom version upon request.
ACCESSORIES	Poured glass spot: Crystal - code 8000336 - 150,00 €* Red - code 8000295 - 150,00 €* Acquamarine - code 8000296 - 150,00 €* (*vat excluded)

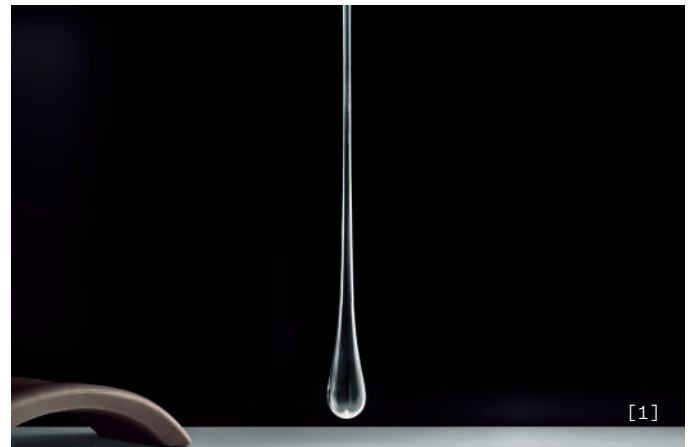

## PRICE LIST

FINISH	H	CODE	UNIT PRICE vat excluded
[1] White Sfumato + Chrome	h85cm [h33 1/2"]	0002821	1.185,00 €
[2] Red + Chrome	h85cm [h33 1/2"]	0002824	1.185,00 €
[3] Acquamarine + Chrome	h85cm [h33 1/2"]	0002827	1.185,00 €
FINISH	H	CODE	UNIT PRICE vat excluded
[1] White Sfumato + Chrome	h150cm [h59"]	0002984	1.547,00 €
[2] Red + Chrome	h150cm [h59"]	0002988	1.547,00 €
[3] Acquamarine + Chrome	h150cm [h59"]	0002992	1.547,00 €
FINISH	H	CODE	UNIT PRICE vat excluded
[1] White Sfumato + Chrome	h210cm [h82 5/8"]	0002904	1.830,00 €
[2] Red + Chrome	h210cm [h82 5/8"]	0002907	1.830,00 €
[3] Acquamarine + Chrome	h210cm [h82 5/8"]	0002910	1.830,00 €
FINISH	H	CODE	UNIT PRICE vat excluded
[1] White Sfumato + Chrome	h270cm [h106 1/4"]	0002928	1.830,00 €
[2] Red + Chrome	h270cm [h106 1/4"]	0002932	1.830,00 €
[3] Acquamarine + Chrome	h270cm [h106 1/4"]	0002936	1.830,00 €

## GLÒ S - INDOOR

Danilo De Rossi, 2010

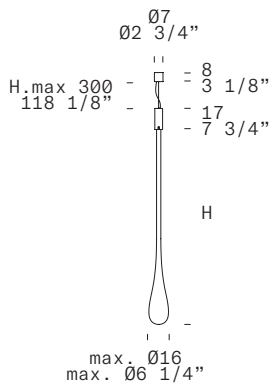

### TECHNICAL SHEET

MATERIALS	Diffuser: Blown Glass Structure: Metal
DIMENSIONS	Diffuser: h85cm [h33 1/2"] h150cm [h59"] h210cm [h82 5/8"] h270cm [h106 1/4"]
FINISHES (DIFFUSER + STRUCTURE)	[1] White Sfumato + Chrome [2] Red + Chrome [3] Acquamarine + Chrome
LIGHT SOURCE	GU10 1 x 7W Retrofit LED (1 x max 50W Halogen Bulb)
MARKING	DRY LOCATION
PACKAGING	-Structure Gross weight: 1,4kg - 0,032m <sup>3</sup> Dimensions: 40x40x20cm -Diffuser h85cm [h33 1/2"] Gross weight: 11kg - 0,19m <sup>3</sup> Dimensions: 132x37x37,4cm -Diffuser h150cm [h59"] Gross weight: 11,2kg - 0,16m <sup>3</sup> Dimensions: 170x30x30cm -Diffuser h210cm [h82 5/8"] Gross weight: 25kg - 0,49m <sup>3</sup> Dimensions: 282x40x43cm -Diffuser h270cm [h106 1/4"] Gross weight: 31,2kg - 0,58m <sup>3</sup> Dimensions: 33,2x40x43cm
NOTE	The weight can be according to the thickness of the glass. The size of the drop diameter varies in proportion to the product height (max Ø16cm Ø6 1/4"). Custom version upon request.
ACCESSORIES	Poured glass spot: Crystal - code 8000336 - 150,00 €* Red - code 8000295 - 150,00 €* Acquamarine - code 8000296 - 150,00 €* (*vat excluded)

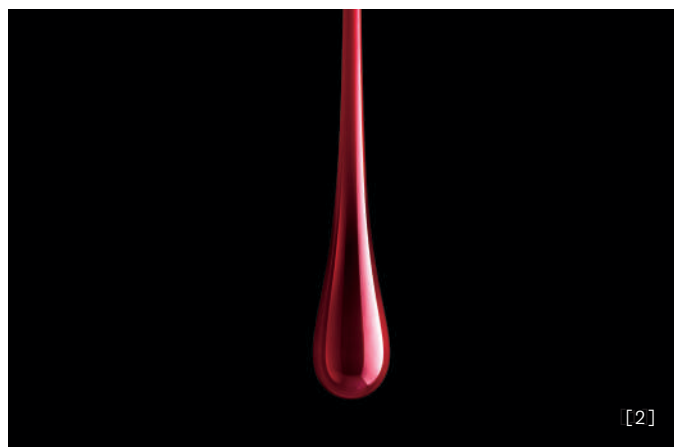

### PRICE LIST

FINISH	H	CODE	UNIT PRICE vat excluded
[1] White Sfumato + Chrome	h85cm [h33 1/2"]	0003114	1.224,00 €
[2] Red + Chrome	h85cm [h33 1/2"]	0003116	1.224,00 €
[3] Acquamarine + Chrome	h85cm [h33 1/2"]	0003118	1.224,00 €
FINISH	H	CODE	UNIT PRICE vat excluded
[1] White Sfumato + Chrome	h150cm [h59"]	0003159	1.594,00 €
[2] Red + Chrome	h150cm [h59"]	0003162	1.594,00 €
[3] Acquamarine + Chrome	h150cm [h59"]	0003165	1.594,00 €
FINISH	H	CODE	UNIT PRICE vat excluded
[1] White Sfumato + Chrome	h210cm [h82 5/8"]	0003187	1.926,00 €
[2] Red + Chrome	h210cm [h82 5/8"]	0003189	1.926,00 €
[3] Acquamarine + Chrome	h210cm [h82 5/8"]	0003191	1.926,00 €
FINISH	H	CODE	UNIT PRICE vat excluded
[1] White Sfumato + Chrome	h270cm [h106 1/4"]	0003400	1.926,00 €
[2] Red + Chrome	h270cm [h106 1/4"]	0003403	1.926,00 €
[3] Acquamarine + Chrome	h270cm [h106 1/4"]	0003406	1.926,00 €

# GLÒ S/I - INDOOR

Danilo De Rossi, 2010

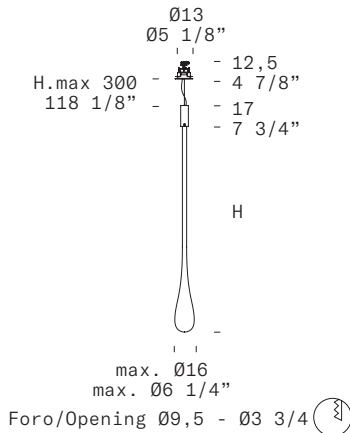

## TECHNICAL SHEET

MATERIALS	Diffuser: Blown Glass Structure: Metal
DIMENSIONS	Diffuser: h85cm [h33 1/2"] h150cm [h59"] h210cm [h82 5/8"] h270cm [h106 1/4"]
FINISHES (DIFFUSER + STRUCTURE)	[1] White Sfumato + Chrome [2] Red + Chrome [3] Acquamarine + Chrome
	 [1]  [3]
	 [2]
LIGHT SOURCE	GU10 1 x 7W Retrofit LED (1 x max 50W Halogen Bulb)
MARKING	DRY LOCATION   
PACKAGING	-Structure Gross weight: 1,4kg - 0,032m <sup>3</sup> Dimensions: 40x40x20cm -Diffuser h85cm [h33 1/2"] Gross weight: 11kg - 0,19m <sup>3</sup> Dimensions: 132x37x37,4cm -Diffuser h150cm [h59"] Gross weight: 11,2kg - 0,16m <sup>3</sup> Dimensions: 170x30x30cm -Diffuser h210cm [h82 5/8"] Gross weight: 25kg - 0,49m <sup>3</sup> Dimensions: 282x40x43cm -Diffuser h270cm [h106 1/4"] Gross weight: 31,2kg - 0,58m <sup>3</sup> Dimensions: 33,2x40x43cm
NOTE	The weight can be according to the thickness of the glass. The size of the drop diameter varies in proportion to the product height (max $\varnothing 16$ cm $\varnothing 6 \frac{1}{4}''$ ). Custom version upon request.
ACCESSORIES	Poured glass spot: Crystal - code 8000336 - 150,00 €* Red - code 8000295 - 150,00 €* Acquamarine - code 8000296 - 150,00 €* (*vat excluded)

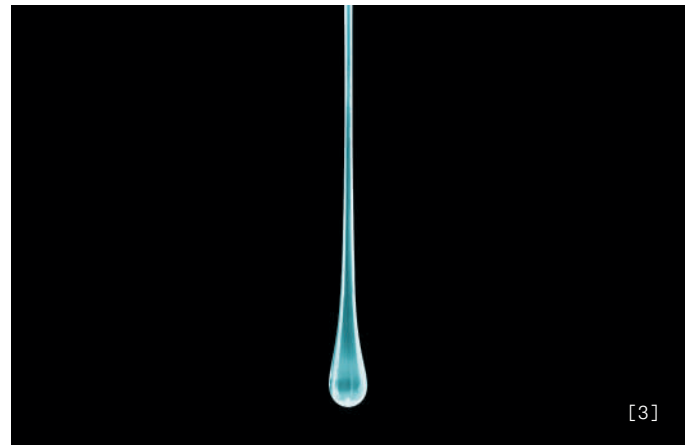

## PRICE LIST

FINISH	H	CODE	UNIT PRICE vat excluded
[1] White Sfumato + Chrome	h85cm [h33 1/2"]	0003424	1.281,00 €
[2] Red + Chrome	h85cm [h33 1/2"]	0003427	1.281,00 €
[3] Acquamarine + Chrome	h85cm [h33 1/2"]	0003430	1.281,00 €
FINISH	H	CODE	UNIT PRICE vat excluded
[1] White Sfumato + Chrome	h150cm [h59"]	0003460	1.680,00 €
[2] Red + Chrome	h150cm [h59"]	0003463	1.680,00 €
[3] Acquamarine + Chrome	h150cm [h59"]	0003466	1.680,00 €
FINISH	H	CODE	UNIT PRICE vat excluded
[1] White Sfumato + Chrome	h210cm [h82 5/8"]	0003496	2.012,00 €
[2] Red + Chrome	h210cm [h82 5/8"]	0003499	2.012,00 €
[3] Acquamarine + Chrome	h210cm [h82 5/8"]	0003502	2.012,00 €
FINISH	H	CODE	UNIT PRICE vat excluded
[1] White Sfumato + Chrome	h270cm [h106 1/4"]	0003532	2.012,00 €
[2] Red + Chrome	h270cm [h106 1/4"]	0003535	2.012,00 €
[3] Acquamarine + Chrome	h270cm [h106 1/4"]	0003538	2.012,00 €

**KEYRA S 30 - INDOOR**

Roberto Paoli, 2011

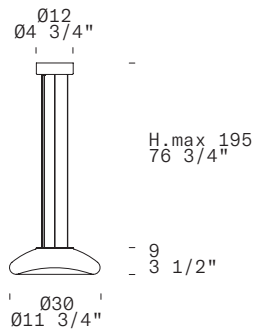

TECHNICAL SHEET

MATERIALS	Diffuser: Blown Glass Structure: Metal
DIMENSIONS	Diffuser: $\varnothing 31\text{cm}$ h $9\text{cm}$ [ $\varnothing 11 \frac{3}{4}$ " h $3 \frac{1}{2}$ "] Canopy: $\varnothing 12\text{cm}$ [ $\varnothing 4 \frac{3}{4}$ "] Cable lenght: $190\text{cm}$ [ $74 \frac{3}{4}$ "]
FINISHES (DIFFUSER + STRUCTURE)	Transparent-Satin White + Glossy White 
LIGHT SOURCE	LED 1 x 13W 900lm (nominal) 3000K
MARKING	DRY LOCATION   
PACKAGING	Gross weight: 2,8kg - $0,40\text{m}^3$ Dimensions: 32x30x12,3cm (box structure) 40x40x20cm (box diffusers)

PRICE LIST

FINISH	SOURCE	CODE	UNIT PRICE vat excluded
Transparent-Satin White + Glossy White	3000K LED	0002304	766,00 €

Bottom view





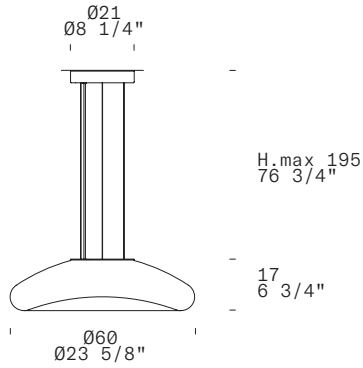

# KEYRA S 60 - INDOOR

Roberto Paoli, 2011



## TECHNICAL SHEET

MATERIALS	Diffuser: Blown Glass Structure: Metal
DIMENSIONS	Diffuser: $\varnothing 60$ cm h17cm [ $\varnothing 23$ 5/8" h6 3/4"] Canopy: $\varnothing 21$ cm [ $\varnothing 8$ 1/4"] Cable length: 190cm [74 3/4"]
FINISHES (DIFFUSER + STRUCTURE)	Transparent-Satin White + Gloss White 
LIGHT SOURCE	LED 2 x 13W 1800lm (nominal) 3000K CRI $\geq$ 90
MARKING	DRY LOCATION   
PACKAGING	Dimensions: 32x30x12,3cm (box structure) 75,5x75,5x26cm (box diffusers)

Bottom view



## PRICE LIST

FINISH	SOURCE	CODE	UNIT PRICE vat excluded
Transparent- Satin White + Gloss White	3000K LED	0002306	1.421,00 €



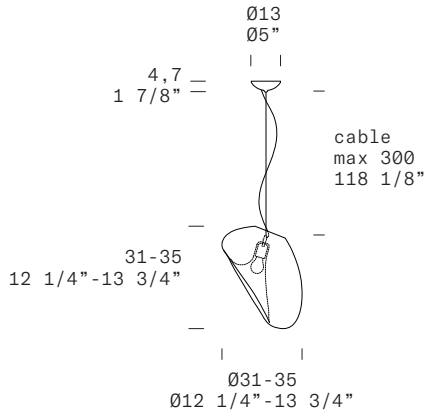

**LIGHTBODY S - INDOOR**

Jörg Hugo, 2021

new



TECHNICAL SHEET

MATERIALS	Diffuser: Glass Structure: Metal
DIMENSIONS	Diffuser: Ø31-35cm h31-35cm [Ø12 1/4-13 3/4" h12 1/4"-13 3/4"] Canopy: Ø13cm h4,7cm [Ø5" h1 7/8"] Cable length: 300cm [118 1/8"]
FINISHES (DIFFUSER + STRUCTURE)	Transparent + Matte Black 
LIGHT SOURCE	E27 1 x 10W Retrofit LED (1 x max 43W Halogen Bulb)
MARKING	DRY LOCATION   
PACKAGING	Gross weight: 5kg - 0,06m³ Dimensions: 43,5x43,5x35cm

PRICE LIST

FINISH	SOURCE	CODE	UNIT PRICE vat excluded
Transparent + Matte Black	E27	0011514	682,00 €
ACCESSORIES	COLOR	CODE	UNIT PRICE vat excluded
Off centre kit 1	chrome	8000150	20,00 €
	nickel	8000151	20,00 €
Off centre kit 2	chrome	8000135	108,00 €
	nickel	8000136	99,00 €

Front view





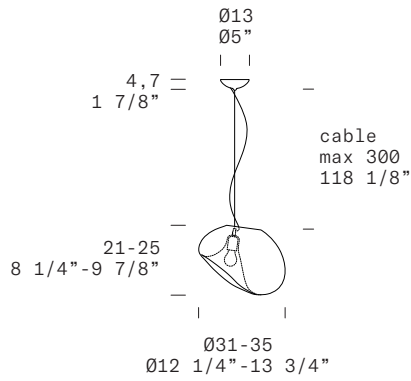

# LIGHTBODY BOLD S - INDOOR

Jörg Hugo, 2021

new



## TECHNICAL SHEET

MATERIALS	Diffuser: Glass Structure: Metal
DIMENSIONS	Diffuser: $\varnothing 31-35$ cm h21-25cm [ $\varnothing 12$ 1/4"-13 3/4" h8 1/4"-9 7/8"] Canopy: $\varnothing 13$ cm h4,7cm [05" h1 7/8"] Cable length: 300cm [118 1/8"]
FINISHES (DIFFUSER + STRUCTURE)	Transparent + Matte Black 
LIGHT SOURCE	E27 1 x 10W Retrofit LED (1 x max 43W Halogen Bulb)
MARKING	DRY LOCATION   
PACKAGING	Gross weight: 5kg - 0,06m <sup>3</sup> Dimensions: 43,5x43,5x35cm

Side view



## PRICE LIST

FINISH	SOURCE	CODE	UNIT PRICE vat excluded
Transparent + Matte Black	E27	0011515	659,00 €



ACCESSORIES	COLOR	CODE	UNIT PRICE vat excluded
Off centre kit 1	chrome	8000150	20,00 €
	nickel	8000151	20,00 €
Off centre kit 2	chrome	8000135	108,00 €
	nickel	8000136	99,00 €

**LILITH S 40 - INDOOR**

Leucos Design Lab, 2006

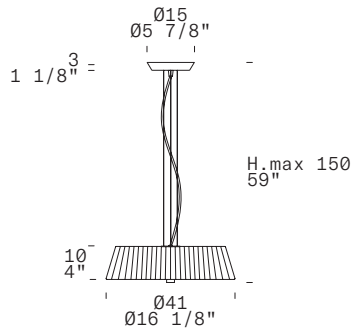

TECHNICAL SHEET

MATERIALS	Diffuser: Cotton Thread Structure: Metal
DIMENSIONS	Diffuser: Ø41cm h10cm [Ø16 1/8" h10 4"] Canopy: Ø15cm h3cm [Ø5 7/8" h1 1/8"] Cable: 150cm [59"]
FINISHES (DIFFUSER + STRUCTURE)	[1] Silver + Brushed Nickel [2] White + Brushed Nickel [3] Mocha + Brushed Nickel  
LIGHT SOURCE	E14 3 x 5W Retrofit LED (3 x max 46W Halogen Bulb)
MARKING	DRY LOCATION  
PACKAGING	Gross weight: 4,5kg - 0,05m³ Dimensions: 46x46x25,5cm

PRICE LIST

FINISH	SOURCE	CODE	UNIT PRICE vat excluded
[1] Silver + Brushed Nickel	E14	0000083	248,00 €
[2] White + Brushed Nickel	E14	0000089	248,00 €
[3] Mocha + Brushed Nickel	E14	0000106	248,00 €





# LILITH S 55 - INDOOR

Leucos Design Lab, 2006

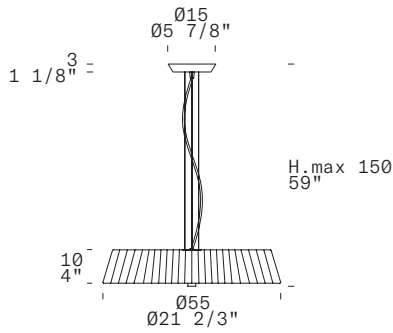

## TECHNICAL SHEET

MATERIALS	Diffuser: Cotton Thread Structure: Metal
DIMENSIONS	Diffuser: Ø55cm h10cm [Ø21 2/3" h10 4"] Canopy: Ø15cm h3cm [Ø5 7/8" h1 1/8"] Cable: 150cm [59"]
FINISHES (DIFFUSER + STRUCTURE)	[1] Silver + Brushed Nickel [2] White + Brushed Nickel [3] Mocha + Brushed Nickel
LIGHT SOURCE	E27 4 x 10W Retrofit LED (4 x max 57W Halogen Bulb)
MARKING	DRY LOCATION  IP20
PACKAGING	Gross weight: 6,8kg - 0,09m <sup>3</sup> Dimensions: 62x62x24cm



[3]

## PRICE LIST

FINISH	SOURCE	CODE	UNIT PRICE vat excluded
[1] Silver + Brushed Nickel	E27	0000084	308,00 €
[2] White + Brushed Nickel	E27	0000090	308,00 €
[3] Mocha + Brushed Nickel	E27	0000107	308,00 €



**LILITH S 70 - INDOOR**

Leucos Design Lab, 2006

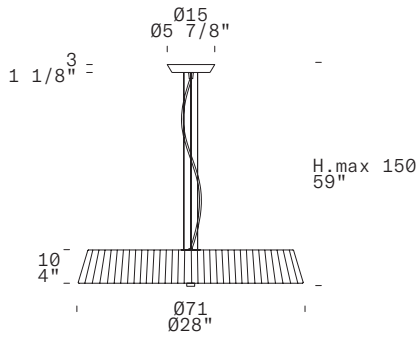

TECHNICAL SHEET

MATERIALS	Diffuser: Cotton Thread Structure: Metal
DIMENSIONS	Diffuser: Ø71cm h10cm [Ø28" 4"] Canopy: Ø15cm h3cm [Ø5 7/8" h1 1/8"] Cable: 150cm [59"]
FINISHES (DIFFUSER + STRUCTURE)	[1] Silver + Brushed Nickel [2] White + Brushed Nickel [3] Mocha + Brushed Nickel
LIGHT SOURCE	E27 6 x 10W Retrofit LED (6 x max 57W Halogen Bulb)
MARKING	DRY LOCATION  IP20
PACKAGING	Gross weight: 8,4kg - 0,16m³ Dimensions: 79x79x26cm

PRICE LIST

FINISH	SOURCE	CODE	UNIT PRICE vat excluded
[1] Silver + Brushed Nickel	E27	0000121	358,00 €
[2] White + Brushed Nickel	E27	0000125	358,00 €
[3] Mocha + Brushed Nickel	E27	0000136	358,00 €

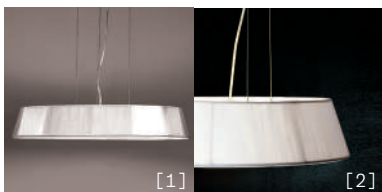

# VOLTA S 120 - INDOOR

From, 2015

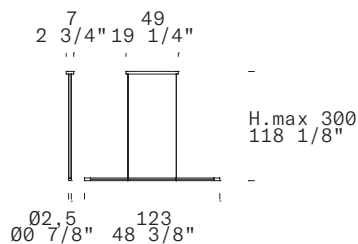

## TECHNICAL SHEET

MATERIALS	Diffuser: Metracrylate (PMMA) Structure: Aluminium
DIMENSIONS	Diffuser: 123cm Ø2,5cm [48 3/8" Ø 7/8"] Canopy: 49cm X 7cm [19 1/4" X 2 3/4"] Cable: 300cm [118 1/8"]
FINISHES (DIFFUSER + STRUCTURE)	[1] Satin Methacrylate + Matte White [2] Satin Methacrylate + Textured Black RAL 9004
	<p>[1] </p> <p>[2] </p>
LIGHT SOURCE	LED 1 x 23W 1950lm (nominal) 2700K CRI≥90
MARKING	DRY LOCATION
PACKAGING	Gross weight: 2,4kg - 0,05m <sup>3</sup> Dimensions: 164x16x18,5cm
NOTE	Push dimmer Patented hanging system: 360° rotation Cable Insulation Kit included

Push dimmer      360° rotation

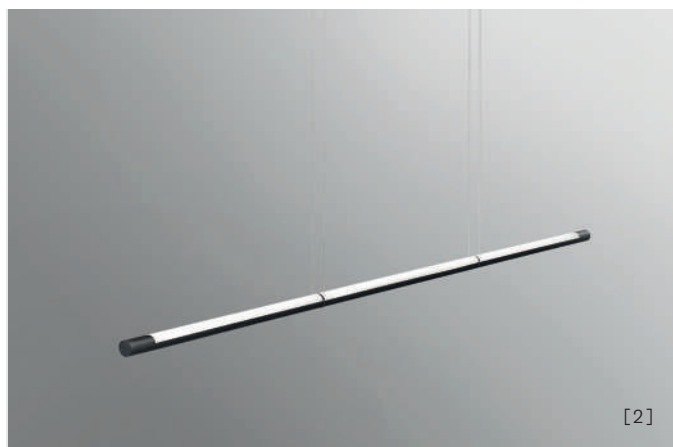
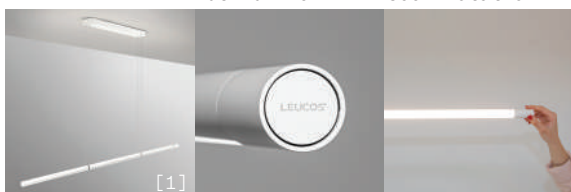

## PRICE LIST

FINISH	SOURCE	CODE	UNIT PRICE vat excluded
[1] Satin Methacrylate + Matte White	2700K LED	0004436	1.020,00 €
[2] Satin Methacrylate + Textured Black RAL 9004	2700K LED	0008311	1.215,00 €

**VOLTA S 160 - INDOOR**

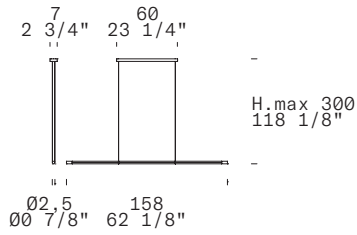

From, 2015



TECHNICAL SHEET

MATERIALS	Diffuser: Metracrylate (PMMA) Structure: Aluminium
DIMENSIONS	Diffuser: 158cm Ø2,5cm [62 1/8" Ø0 7/8"] Canopy: 60cm X 7cm [23 1/4" X 2 3/4"] Cable: 300cm [118 1/8"]
FINISHES (DIFFUSER + STRUCTURE)	[1] Satin Methacrylate + Matte White [2] Satin Methacrylate + Textured Black RAL 9004



LIGHT SOURCE	LED 1 x 30W 2560lm (nominal) 2700K CRI≥90
MARKING	DRY LOCATION  
PACKAGING	Gross weight: 2,4kg - 0,05m³ Dimensions: 164x16x18,5cm
NOTE	Push dimmer Patented hanging system: 360° rotation Cable Insulation Kit included

PRICE LIST

FINISH	SOURCE	CODE	UNIT PRICE vat excluded
[1] Satin Methacrylate + Matte White	LED 2700K	0004437	1.120,00 €
[2] Satin Methacrylate + Textured Black RAL 9004	LED 2700K	0008315	1.334,00 €

Push dimmer      360° rotation



EN WALL

CEILING

IT PARETE

SOFFITTO



**ALIAS P 15 - INDOOR**  
Works Studio, 2004

USER REPLACEABLE LED

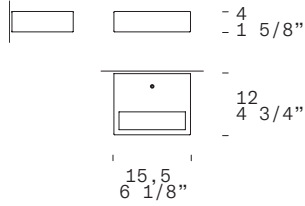
upgraded LED



TECHNICAL SHEET

MATERIALS	Diffuser: Plastic Structure: Metal
DIMENSIONS	15cm x 12cm h4 [5 7/8" X 4 3/4" h1 5/8"]
FINISHES (DIFFUSER + STRUCTURE)	[1] Gloss Methacrylate + White [2] Gloss Methacrylate + Chrome [3] Gloss Methacrylate + Brushed Brass 
LIGHT SOURCE	LED 2 x 6,4W 1880lm (nominal) 3000K CRI≥90 [E]
CONTROL	Phase-cut
MARKING	DRY LOCATION  
PACKAGING	Gross weight: 2kg - 0,02m³ Dimensions: 15,5x7,8x18,5cm

PRICE LIST

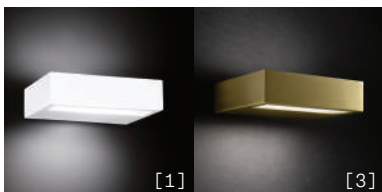

CONTROL	Phase-cut		
	FINISH	SOURCE	CODE
[1] Gloss Methacrylate + White	3000K LED	0012209	242,00 €
[2] Gloss Methacrylate + Chrome	3000K LED	0012207	326,00 €
[3] Gloss Methacrylate + Brushed Brass	3000K LED	0012247	326,00 €

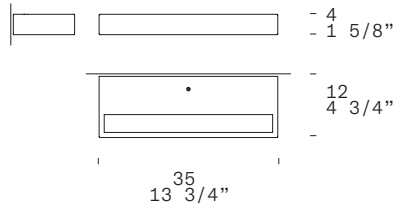

upgraded LED



TECHNICAL SHEET

MATERIALS	Diffuser: Plastic Structure: Metal
DIMENSIONS	35cm x 12cm h4 [13 3/4" X 4 3/4" h 1 5/8"]
FINISHES (DIFFUSER + STRUCTURE)	[1] Gloss Methacrylate + White [2] Gloss Methacrylate + Chrome [3] Gloss Methacrylate + Brushed Brass  
LIGHT SOURCE	LED 2 x 12,8W 3760lm (nominal) 3000K CRI≥90 [E]
CONTROL	Phase-cut
MARKING	DRY LOCATION  
PACKAGING	Gross weight: 2,8kg - 0,05m <sup>3</sup> Dimensions: 16,2x7,8x39,5cm

PRICE LIST

CONTROL	Phase-cut		
	FINISH	SOURCE	CODE
[1] Gloss Methacrylate + White	3000K LED	0012210	291,00 €
[2] Gloss Methacrylate + Chrome	3000K LED	0012208	449,00 €
[3] Gloss Methacrylate + Brushed Brass	3000K LED	0012251	449,00 €



**BETA SMALL P-PL - INDOOR**

USER REPLACEABLE LED

Poalo Franzin, 2010

upgraded LED

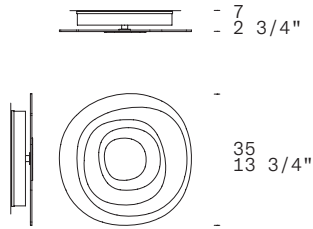

TECHNICAL SHEET

MATERIALS	Diffuser: Glass Plates Structure: Steel
DIMENSIONS	Ø35cm h5,5cm [Ø13 3/4" h2 1/8"]
FINISHES (DIFFUSER + STRUCTURE)	Gloss White (with light Off) shaded of sand (with light On) + Satin Steel 
LIGHT SOURCE	LED 1 x 10W 1446lm (nominal) 3000K CRI≥90 [E]
CONTROL (LED version)	Push-dim; 0/1-10V Phase cut
MARKING	DRY LOCATION  
PACKAGING	Gross weight: 3,7kg - 0,07m³ Dimensions Structure: 40x40x20cm Dimensions Glass: 45x45x20cm

with light Off    with light On

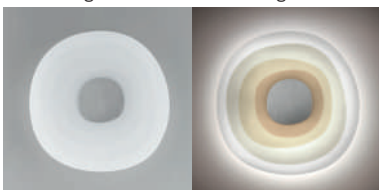

PRICE LIST

CONTROL		Push-dim; 0/1-10V	
FINISH	SOURCE	CODE	UNIT PRICE vat excluded
Gloss White (with light Off) shaded of sand (with light On) + Satin Steel	3000K LED	0012216	390,00 €





CONTROL		Phase-cut	
FINISH	SOURCE	CODE	UNIT PRICE vat excluded
Gloss White (with light Off) shaded of sand (with light On) + Satin Steel	3000K LED	0012217	390,00 €

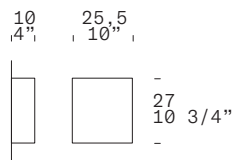

upgraded LED



TECHNICAL SHEET

MATERIALS	Diffuser: Blown Glass Structure: Metal
DIMENSIONS	Diffuser: 25,5cm h27cm [10" h10 3/4"]
FINISHES (DIFFUSER + STRUCTURE)	Satin White + Brushed Nickel 
LIGHT SOURCE	E27 1 x 10W Retrofit LED (max 1 X 100W Halogen Bulb) LED 1 x 10W 1446lm (nominal) 3000K CRI≥90 [E] LED 1 x 10W 1398lm (nominal) 2700K CRI≥90 [E]
CONTROL (LED version)	Push-dim; 0/1-10V Phase cut
MARKING	DRY LOCATION   
PACKAGING	Gross weight: 2,7kg - 0,06m <sup>3</sup> Dimensions: 30x41x46cm

PRICE LIST

FINISH	SOURCE	CODE	UNIT PRICE vat excluded
Satin White + Brushed Nickel	E27	0003805	219,00 €

CONTROL	Push-dim; 0/1-10V		
FINISH	SOURCE	CODE	UNIT PRICE vat excluded
Satin White + Brushed Nickel	3000K LED 2700K LED	0012212 0012235	374,00 € 374,00 €

CONTROL	Phase-cut		
FINISH	SOURCE	CODE	UNIT PRICE vat excluded
Satin White + Brushed Nickel	3000K LED 2700K LED	0012213 0012237	374,00 € 374,00 €



**CELINE P 35 - INDOOR**  
Leucos Design Lab, 2002

USER REPLACEABLE LED

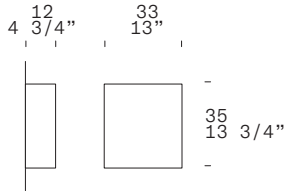
upgraded LED



TECHNICAL SHEET

MATERIALS	Diffuser: Blown Glass Structure: Metal
DIMENSIONS	Diffuser: 33cm x 12cm h35cm [13" X 4 3/4" h13 3/4"]
FINISHES (DIFFUSER + STRUCTURE)	Satin White + Brushed Nickel 
LIGHT SOURCE	E27 1 x 10W Retrofit LED (max 1 X 150W Halogen Bulb) LED 1 x 10W 1446lm (nominal) 3000K CRI≥90 [E] LED 1 x 10W 1398lm (nominal) 2700K CRI≥90 [E]
CONTROL (LED version)	Push-dim; 0/1-10V Phase cut
MARKING	DRY LOCATION 
PACKAGING	Gross weight: 2,7kg - 0,05m <sup>3</sup> Dimensions: 47x50x20cm

PRICE LIST

FINISH	SOURCE	CODE	UNIT PRICE vat excluded
Satin White + Brushed Nickel	E27	0003955	318,00 €



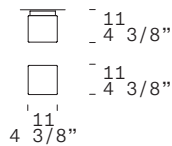

CONTROL	Push-dim; 0/1-10V		
FINISH	SOURCE	CODE	UNIT PRICE vat excluded
Satin White + Brushed Nickel	3000K LED	0012214	429,00 €
	2700K LED	0012239	429,00 €

CONTROL	Phase-cut		
FINISH	SOURCE	CODE	UNIT PRICE vat excluded
Satin White + Brushed Nickel	3000K LED	0012215	429,00 €
	2700K LED	0012241	429,00 €

**CUBI P-PL 11 - INDOOR**  
Leucos Design Lab, 2000

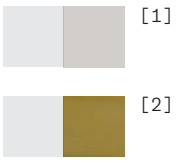

TECHNICAL SHEET

MATERIALS	Diffuser: Blown and Layered Glass Structure: Polycarbonate (G9), Anodized Aluminium (LED)		
DIMENSIONS	11cm x 11cm [4 3/8" X 4 3/8"]		
FINISHES (DIFFUSER + STRUCTURE)	[1] Satin White + Grey [2] Satin White + Brushed Brass 		
LIGHT SOURCE	G9 1 x 3w Retrofit LED [A+/D] (max 1 x 33W Halogen Bulb) LED 1 x 5W 500lm (nominal) 3000K IP20 [E] LED 1 x 4W 500lm (nominal) 2700K IP20 [E] LED 1 x 4W 500lm (nominal) 2700K IP44 [F]		
MARKING	DRY LOCATION   DAMP LOCATION  		
PACKAGING	Gross weight: 1,1kg - 0,005m <sup>3</sup> Dimensions: 12,6x14,6x17,2cm		

Front view



PRICE LIST

FINISH	SOURCE	CODE	UNIT PRICE vat excluded
[1] Satin White + Grey	G9	0001710	128,00 €

FINISH	SOURCE	CODE	UNIT PRICE vat excluded
[1] Satin White + Grey	3000K LED IP20	0001712	235,00 €
[2] Satin White + Brushed Brass	3000K LED IP20	0011040	261,00 €

FINISH	SOURCE	CODE	UNIT PRICE vat excluded
[1] Satin White + Grey	2700K LED IP20	0001787	198,00 €
[2] Satin White + Brushed Brass	2700K LED IP20	0011042	223,00 €

FINISH	SOURCE	CODE	UNIT PRICE vat excluded
[1] Satin White + Grey	2700K LED IP44	0001785	268,00 €
[2] Satin White + Brushed Brass	2700K LED IP44	0011041	293,00 €

**CUBI P-PL 16 - INDOOR**

Leucos Design Lab, 2000

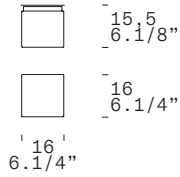

TECHNICAL SHEET

MATERIALS	Diffuser: Blown and Layered Glass Structure: Polycarbonate (G9), Anodized Aluminium (LED)		
DIMENSIONS	16cm x 16cm [6 1/4" X 6 1/4"] 9		
FINISHES (DIFFUSER + STRUCTURE)	[1] Satin White + Grey [2] Satin White + Brushed Brass 		
LIGHT SOURCE	G9 1 x 3w Retrofit LED [A+/D] (max 1 x 33W Halogen Bulb) LED 3 x 5,8W 1320lm (nominal) 3000K IP20 [E] LED 2 x 6W 1440lm (nominal) 2700K IP20 [E] LED 2 x 6W 1440lm (nominal) 2700K IP44 [F]		
CONTROL	Phase-cut (LED 2 x 6W 1440lm 2700K version)		
MARKING	DRY LOCATION		
	DAMP LOCATION		
PACKAGING	Gross weight: 1kg - 0,013m <sup>3</sup> (G9 version) Gross weight: 2,2kg - 0,013m <sup>3</sup> (LED version) Dimensions: 30,4x19,8x22cm		

Front view

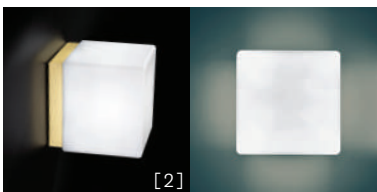

[2]



[1]

PRICE LIST

FINISH	SOURCE	CODE	UNIT PRICE vat excluded
[1] Satin White + Grey	G9	0001670	161,00 €

FINISH	SOURCE	CODE	UNIT PRICE vat excluded
[1] Satin White + Grey	3000K LED IP20	0001671	286,00 €
[2] Satin White + Brushed Brass	3000K LED IP20	0011049	316,00 €

CONTROL	Phase-cut		
FINISH	SOURCE	CODE	UNIT PRICE vat excluded
[1] Satin White + Grey	2700K LED IP20	0001788	272,00 €
[2] Satin White + Brushed Brass	2700K LED IP20	0011051	324,00 €
NOTE	*ALL PRICES ARE VAT EXCLUDED		



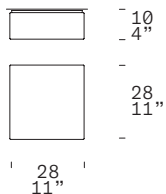

CONTROL	Phase-cut		
FINISH	SOURCE	CODE	UNIT PRICE vat excluded
[1] Satin White + Grey	2700K LED IP44	0001786	332,00 €
[2] Satin White + Brushed Brass	2700K LED IP44	0011050	380,00 €

# CUBI P-PL 28 - INDOOR

Leucos Design Lab, 2000



## TECHNICAL SHEET

MATERIALS	Diffuser: Blown an Layered Glass Structure: Metal
DIMENSIONS	28cm X 28cm h10cm [11" X 11" h4"]
FINISHES (DIFFUSER + STRUCTURE)	Satin White + Grey 
LIGHT SOURCE	E14 4 x 5W Retrofit LED [A+/E] (4 x max 30W Halogen Bulb) LED 1 x 15W 1800lm (nominal) 3000K
MARKING	DRY LOCATION   
PACKAGING	Gross weight: 4kg - 0,03-m <sup>3</sup> Dimensions: 40x40x20cm

Wall view

Front view



## PRICE LIST

FINISH	SOURCE	CODE	UNIT PRICE vat excluded
Satin White + Grey	E14	0001709	329,00 €

FINISH	SOURCE	CODE	UNIT PRICE vat excluded
Satin White + Grey	LED 3000K	0001804	388,00 €

**KEYRA P-PL 30 - INDOOR**

Roberto Paoli, 2011

USER REPLACEABLE LED

upgraded LED

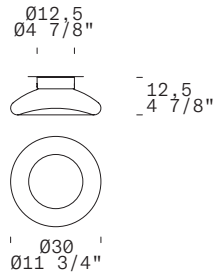

TECHNICAL SHEET

MATERIALS	Diffuser: Blown Glass Structure: Metal		
DIMENSIONS	Ø30cm h12,5cm [Ø11 3/4" h4 7/8"]		
FINISHES (DIFFUSER + STRUCTURE)	Transparent/Satin White + Gloss White		
LIGHT SOURCE	LED 1 x 8,2W 1119lm (nominal) 3000K CRI≥90 [E]		
CONTROL (LED version)	Push-dim; 0/1-10V Phase cut		
MARKING	DRY LOCATION		
PACKAGING	Gross weight: 2,5kg - 0,03-m <sup>3</sup> Dimensions: 40x40x20cm		

PRICE LIST

CONTROL		Push-dim; 0/1-10V	
FINISH	SOURCE	CODE	UNIT PRICE vat excluded
Transparent/Satin White + Gloss White	3000K LED	0012221	659,00 €

CONTROL		Phase-cut	
FINISH	SOURCE	CODE	UNIT PRICE vat excluded
Transparent/Satin White + Gloss White	3000K LED	0012219	703,00 €

Wall view      Front view





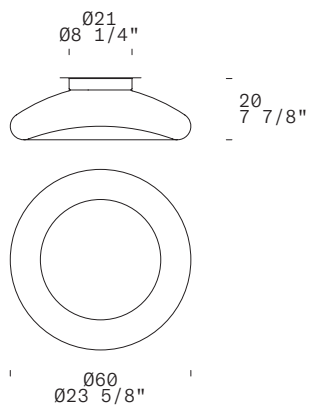

# KEYRA P-PL 60 - INDOOR

Roberto Paoli, 2011



## TECHNICAL SHEET

MATERIALS	Diffuser: Blown Glass Structure: Metal
DIMENSIONS	Ø60cm h20cm [Ø23 5/8" h20 7/8"]
FINISHES (DIFFUSER + STRUCTURE)	Transparent/Satin White + Gloss White 
LIGHT SOURCE	LED 2 x 13W 1800lm (nominal) 3000K
MARKING	DRY LOCATION   
PACKAGING	Gross weight: 11,6kg - 0,16m <sup>3</sup> Dimensions structure: 32x33x12,3cm Dimensions diffuser: 75,5x75,5x26cm

Wall view

Front view



## PRICE LIST

FINISH	SOURCE	CODE	UNIT PRICE vat excluded
Transparent/ Satin White + Gloss White	3000K LED	0002433	1.212,00 €

**LILITH PL 40 - INDOOR**

Leucos Design Lab, 2005

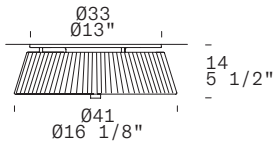

TECHNICAL SHEET

MATERIALS	Diffuser: Cotton Thread Structure: Metal
DIMENSIONS	Diffuser: Ø41cm h14cm [Ø16 1/8" h5 1/2"] Canopy: Ø33cm [Ø13"]
FINISHES (DIFFUSER + STRUCTURE)	[1] Silver + White [2] White + White [3] Mocha + White
LIGHT SOURCE	E14 3 x 5W Retrofit LED (3 x max 30W Halogen Bulb)
MARKING	DRY LOCATION
PACKAGING	Gross weight: 4,8kg - 0,05m <sup>3</sup> Dimensions: 46x46x25,5cm



[3]

PRICE LIST

FINISH	SOURCE	CODE	UNIT PRICE vat excluded
[1] Silver + Brushed Nickel	E14	0000006	263,00 €
[2] White + Brushed Nickel	E14	0000012	263,00 €
[3] Mocha + Brushed Nickel	E14	0000029	263,00 €



# LILITH PL 55 - INDOOR

Leucos Design Lab, 2005

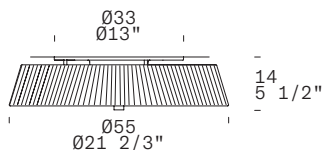

## TECHNICAL SHEET

MATERIALS	Diffuser: Cotton Thread Structure: Metal
DIMENSIONS	Diffuser: Ø55cm h14cm [Ø21 2/3" h5 1/2"] Canopy: Ø33cm [Ø13"]
FINISHES (DIFFUSER + STRUCTURE)	<p>[1] Silver + White [2] White + White [3] Mocha + White</p>
LIGHT SOURCE	E27 4 x 10W Retrofit LED (4 x max 30W Halogen Bulb)
MARKING	DRY LOCATION
PACKAGING	Gross weight: 6,8kg - 0,09m <sup>3</sup> Dimensions: 62x62x24cm





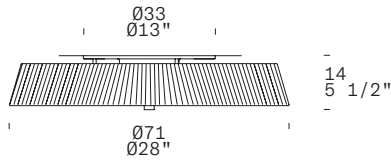

## PRICE LIST

FINISH	SOURCE	CODE	UNIT PRICE vat excluded
[1] Silver + Brushed Nickel	E27	0000007	329,00 €
[2] White + Brushed Nickel	E27	0000013	329,00 €
[3] Mocha + Brushed Nickel	E27	0000030	329,00 €

**LILITH PL 70 - INDOOR**  
 Leucos Design Lab, 2005

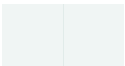

TECHNICAL SHEET

MATERIALS	Diffuser: Cotton Thread Structure: Metal
DIMENSIONS	Diffuser: Ø71cm h14cm [Ø28" h5 1/2"] Canopy: Ø33cm [Ø13"]
FINISHES (DIFFUSER + STRUCTURE)	[1] Silver + White [2] White + White [3] Mocha + White
	 [1]  [2]  [3]
LIGHT SOURCE	E27 6 x 10W Retrofit LED (6 x max 30W Halogen Bulb)
MARKING	DRY LOCATION   
PACKAGING	Gross weight: 8,4kg - 0,16m <sup>3</sup> Dimensions: 79x79x26cm

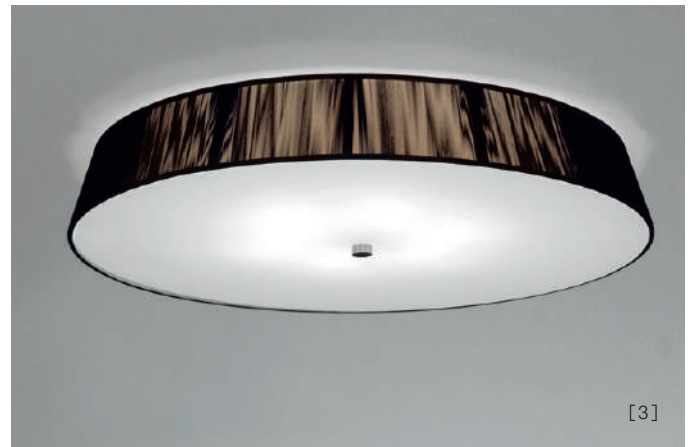

PRICE LIST

FINISH	SOURCE	CODE	UNIT PRICE vat excluded
[1] Silver + Brushed Nickel	E27	0000039	428,00 €
[2] White + Brushed Nickel	E27	0000043	428,00 €
[3] Mocha + Brushed Nickel	E27	0000054	428,00 €

## PASCALE P 40 - INDOOR

Leucos Design Lab, 2015

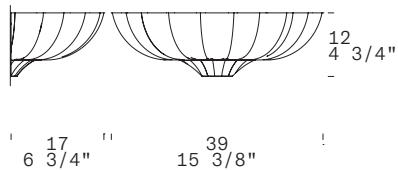

### TECHNICAL SHEET

**MATERIALS** Diffuser: Curved Cast Glass pressed with "Fracco"  
Structure: Metal

**DIMENSIONS** Diffuser: 39cm x 17cm h12cm [15 3/8" x 6 3/4" h4 3/4"]

**FINISHES** Crystal + Chrome  
(DIFFUSER + STRUCTURE)



**LIGHT SOURCE** G9 2 x 3W Retrofit LED  
(max 2 x 33W Halogen Bulb)

**MARKING** DRY LOCATION   

**PACKAGING** Gross weight: 4,6kg - 0,04m<sup>3</sup>  
Dimensions: 45x45x20cm



### PRICE LIST

FINISH	SOURCE	CODE	UNIT PRICE vat excluded
Crystal + Chrome	G9	0000538	387,00 €

**PASCALE PL 30 - INDOOR**

Leucos Design Lab, 2005

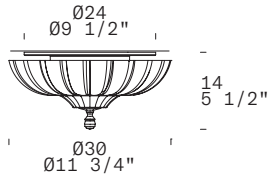

## TECHNICAL SHEET

**MATERIALS** Diffuser: Curved Cast Glass pressed with "Fracco"  
Structure: Metal

**DIMENSIONS** Diffuser: Ø30cm h14cm [Ø11 3/4" h5 1/2"]

**FINISHES** Crystal + Chrome  
(DIFFUSER + STRUCTURE)



**LIGHT SOURCE** G9 3 x 3W Retrofit LED  
(max 3 x 33W Halogen Bulb)

**MARKING** DRY LOCATION   

**PACKAGING** Gross weight: 4kg - 0,04m<sup>3</sup>  
Dimensions: 40x40x20cm



## PRICE LIST

FINISH	SOURCE	CODE	UNIT PRICE vat excluded
Crystal + Chrome	G9	0000410	496,00 €

**PASCALE PL 40 - INDOOR**  
Leucos Design Lab, 2005

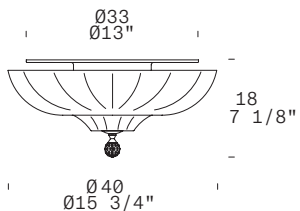

TECHNICAL SHEET

**MATERIALS** Diffuser: Curved Cast Glass pressed with "Fracco"  
Structure: Metal

**DIMENSIONS** Diffuser: 40cm h18cm [15 3/4" h7 1/8"]

**FINISHES (DIFFUSER + STRUCTURE)** Crystal + Chrome



**LIGHT SOURCE** E14 3 x 5W Retrofit LED  
(max 3 x 46W Halogen Bulb)

**MARKING** DRY LOCATION   

**PACKAGING** Gross weight: 7,75kg - 0,08m<sup>3</sup>  
Dimensions: 71x53,5x20,5cm



PRICE LIST



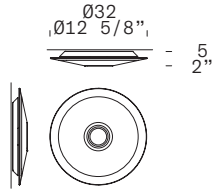

FINISH	SOURCE	CODE	UNIT PRICE vat excluded
Crystal + Chrome	E14	0000385	627,00 €

**PLANET P-PL 32 - INDOOR**

Leucos Design Lab, 2013



TECHNICAL SHEET

MATERIALS	Diffuser: Slumpd and Screen-Printed Glass Structure: Metal
DIMENSIONS	Ø32cm h5cm [Ø12 5/8" h2"]
FINISHES (DIFFUSER + STRUCTURE)	Satin White + Chrome 
LIGHT SOURCE	LED 1 x 10W 1350lm (nominal) 3000K
MARKING	DRY LOCATION   
PACKAGING	Gross weight: 3,8kg - 0,04m³ Dimensions: 40x40x20cm



PRICE LIST

FINISH	SOURCE	CODE	UNIT PRICE vat excluded
Satin White + Chrome	LED 3000K	0003727	292,00 €

Wall view

Ceiling view





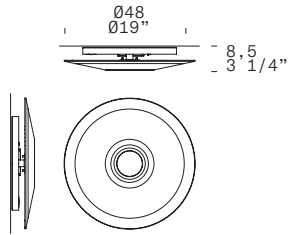

**PLANET P-PL 48 - INDOOR**

Leucos Design Lab, 2008



**TECHNICAL SHEET**

<b>MATERIALS</b>	Diffuser: Slumpd and Screen-Printed Glass Structure: Metal
<b>DIMENSIONS</b>	Ø48cm h8,5cm [Ø19" h3 1/4"]
<b>FINISHES (DIFFUSER + STRUCTURE)</b>	Satin White + Chrome 
<b>LIGHT SOURCE</b>	G9 6 x 3W Retrofit LED [A+/D] (max 6 x 33W Halogen Bulb) LED 1 x 16W 2500lm (nominal) 3000K
<b>CONTROL (LED version)</b>	Push-dim; 0/1-10V
<b>MARKING</b>	DRY LOCATION   
<b>PACKAGING</b>	Gross weight: 3,8kg - 0,09m³ Dimensions: 56x56x28cm

Wall view

Ceiling view

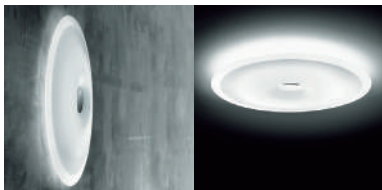

**PRICE LIST**

FINISH	SOURCE	CODE	UNIT PRICE vat excluded
Satin White + Chrome	G9	0003749	402,00 €

CONTROL	Push-dim; 1-10V		
FINISH	SOURCE	CODE	UNIT PRICE vat excluded
Satin White + Chrome	3000K LED	0003751	595,00 €

**PLANET P-PL 65 - INDOOR**

Leucos Design Lab, 2008

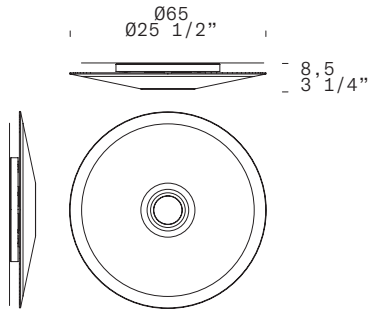

**TECHNICAL SHEET**

**MATERIALS** Diffuser: Slumpd and Screen-Printed Glass  
Structure: Metal



**DIMENSIONS** Ø65cm h8,5cm [Ø25 1/2" h3 1/4"]

**FINISHES (DIFFUSER + STRUCTURE)** Satin White + Chrome



**LIGHT SOURCE** G9 6 x 3W Retrofit LED [A+/D]  
(max 6 x 33W Halogen Bulb)  
LED 6 x 7,5W 60001m (nominal) 3000K

**MARKING** DRY LOCATION

**PACKAGING** Gross weight: 10,2kg - 0,21m<sup>3</sup>  
Dimensions: 81x81x32cm  



**PRICE LIST**

FINISH	SOURCE	CODE	UNIT PRICE vat excluded
Satin White + Chrome	G9	0003754	480,00 €

Wall view

Ceiling view







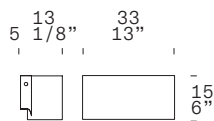

# VITTORIA P 2 - INDOOR

Toso, Massari & Associated, 1992



## TECHNICAL SHEET

MATERIALS	Diffuser: Blown Glass Structure: Metal
DIMENSIONS	Diffuser: 33cm x 13cm h15cm [13" X 5 1/8" h6"]
FINISHES (DIFFUSER + STRUCTURE)	Satin White + Chrome 
LIGHT SOURCE	R7s 80mm 1 x 10W Retrofit LED [A+/D] (max 1 x 120W Halogen Bulb) LED 3 x 5W 1300lm (nominal) 3000K CRI≥90 [E]
CONTROL (LED version)	Phase cut
MARKING	DRY LOCATION   
PACKAGING	Gross weight: 3,5kg - 0,05m <sup>3</sup> Dimensions: 28x47x36cm

wall view



## PRICE LIST

FINISH	SOURCE	CODE	UNIT PRICE vat excluded
Satin White + Chrome	R7s 80mm	0003935	397,00 €

CONTROL	Phase cut		
FINISH	SOURCE	CODE	UNIT PRICE vat excluded
Satin White + Chrome	3000K LED	0003937	456,00 €



EN RECESSED

IT INCASSO

**DROP I - INDOOR**

Toso, Massari & Associates, 1998

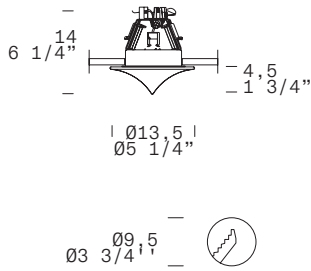

**TECHNICAL SHEET**

<b>MATERIALS</b>	Diffuser: Glass Structure: Metal
<b>DIMENSIONS</b>	Diffuser: Ø13,5cm h4,5cm [Ø5 1/4" h1 3/4"]
<b>FINISHES (DIFFUSER + STRUCTURE)</b>	[1] Crystal + Chrome [2] Satin White + Chrome
	[1] [2]
<b>LIGHT SOURCE</b>	GU5,3 1 x 8W Retrofit LED (1 X max 50W Halogen Bulb) GU10 1 x 50W Halogen Bulb
<b>MARKING</b>	GU5,3: DRY LOCATION GU10: DRY LOCATION
<b>PACKAGING</b>	Gross weight: 0,8kg - 0,008m³ Dimensions: 30x17x14cm

**PRICE LIST**

FINISH	SOURCE	CODE	UNIT PRICE vat excluded
[1] Crystal + Chrome	GU5,3	0004253	149,00 €
[2] Satin White + Chrome	GU5,3	0004252	149,00 €
<b>ACCESSORIES</b>	Electronic Ballast 12V*	8000142	58,00 €
<b>NOTE</b>	Transformer not included *5-70W halogen lamp/2,5-50W LED lamp		

  

FINISH	SOURCE	CODE	UNIT PRICE vat excluded
[1] Crystal + Chrome	GU10	0004255	149,00 €
[2] Satin White + Chrome	GU10	0004254	158,00 €



**ISIDE 2 I - INDOOR**

Roberto Pamio, 1991

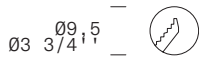
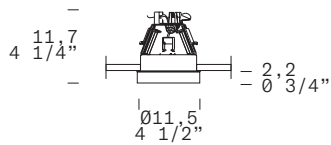

**TECHNICAL SHEET**

<b>MATERIALS</b>	Diffuser: Glass Structure: Metal
<b>DIMENSIONS</b>	Diffuser: Ø11,5cm h2,2cm [Ø4 1/2" h0 3/4"]
<b>FINISHES (DIFFUSER + STRUCTURE)</b>	[1] Crystal + Chrome [2] Satin White + Chrome
	[1] [2]
<b>LIGHT SOURCE</b>	GU5,3 1 x 8W Retrofit LED (1 X max 50W Halogen Bulb) GU10 1 x 50W Halogen Bulb
<b>MARKING</b>	GU5,3: DRY LOCATION GU10: DRY LOCATION
<b>PACKAGING</b>	Gross weight: 0,76kg - 0,008m³ Dimensions: 30x17x14cm



RECESSED - INCASSO

**PRICE LIST**

FINISH	SOURCE	CODE	UNIT PRICE vat excluded
[1] Crystal + Chrome	GU5,3	0004261	149,00 €
[2] Satin White + Chrome	GU5,3	0004260	149,00 €
<b>ACCESSORIES</b>	Electronic Ballast 12V*	8000142	58,00 €
<b>NOTE</b>	Transformer not included *5-70W halogen lamp/2,5-50W LED lamp		
FINISH	SOURCE	CODE	UNIT PRICE vat excluded
[1] Crystal + Chrome	GU10	0004263	149,00 €
[2] Satin White + Chrome	GU10	0004262	158,00 €



**MIRA 2 I - INDOOR**

Roberto Pamio, 1991

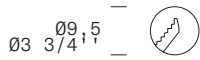
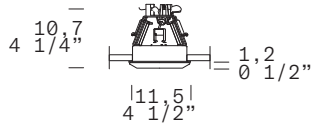

**TECHNICAL SHEET**

<b>MATERIALS</b>	Diffuser: Glass Structure: Metal
<b>DIMENSIONS</b>	Diffuser: 11,5cm h1,2cm [4 1/2" h0 1/2"]
<b>FINISHES (DIFFUSER + STRUCTURE)</b>	[1] Crystal + Chrome [2] Satin White + Chrome
	[1]
	[2]
<b>LIGHT SOURCE</b>	GU5,3 1 x 8W Retrofit LED (1 X max 50W Halogen Bulb) GU10 1 x 50W Halogen Bulb
<b>MARKING</b>	GU5,3: DRY LOCATION GU10: DRY LOCATION
<b>PACKAGING</b>	Gross weight: 0,58kg - 0,008m <sup>3</sup> Dimensions: 30x17x14cm



**PRICE LIST**

FINISH	SOURCE	CODE	UNIT PRICE vat excluded
[1] Crystal + Chrome	GU5,3	0002844	129,00 €
[2] Satin White + Chrome	GU5,3	0002846	139,00 €
<b>ACCESSORIES</b>	Electronic Ballast 12V*	8000142	58,00 €
<b>NOTE</b>	Transformer not included *5-70W halogen lamp/2,5-50W LED lamp		
FINISH	SOURCE	CODE	UNIT PRICE vat excluded
[1] Crystal + Chrome	GU10	0002845	139,00 €
[2] Satin White + Chrome	GU10	0002847	149,00 €

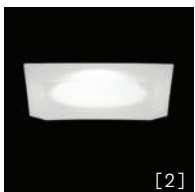

**PEGASO I - INDOOR**

Orietta Indovino, 2000

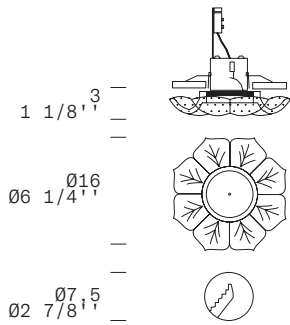

**TECHNICAL SHEET**

<b>MATERIALS</b>	Diffuser: Curved Cast Glass pressed with "Fracco" Structure: Metal
<b>DIMENSIONS</b>	Diffuser: Ø13,5cm h3cm [Ø5 1/8" h1 1/8"]
<b>FINISHES (DIFFUSER + STRUCTURE)</b>	[1] Transparent Graniglia + White [2] Amber Graniglia + White
	[1]
	[2]
<b>LIGHT SOURCE</b>	GU5,3 1 x 8W Retrofit LED (1 x max 50W Halogen Bulb)
<b>MARKING</b>	DRY LOCATION
<b>PACKAGING</b>	Gross weight: 0,8kg - 0,009m³ Dimensions: 25x19x19cm





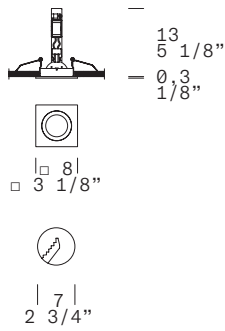

**PRICE LIST**

FINISH	SOURCE	CODE	UNIT PRICE vat excluded
[1] Transparent Graniglia + White	GU5,3	0000313	120,00 €
[2] Amber Graniglia + White	GU5,3	0000315	120,00 €
<b>NOTE</b>	Transformer not included		
ACCESSORIES		CODE	UNIT PRICE vat excluded
Electronic Ballast 12V 5-70W halogen lamp 2,5-50W LED lamp		8000142	58,00 €

**SD 802 I - INDOOR**  
Leucos Design Lab, 2004



TECHNICAL SHEET

MATERIALS	Diffuser: Metal Structure: Metal		
DIMENSIONS	Diffuser: 8cm h0,3cm [3 1/8" h 1/8"]		
FINISHES (DIFFUSER + STRUCTURE)	[1] Brushed Aluminium	[2] White	
	 [1]	 [2]	
LIGHT SOURCE	GU5,3 1 x 8W Retrofit LED (1 x max 50W Halogen Bulb)		
MARKING	DRY LOCATION		 
PACKAGING	Gross weight: 0,5kg - 0,001m <sup>3</sup> Dimensions: 13,5x10x7cm		



PRICE LIST

FINISH	SOURCE	CODE	UNIT PRICE vat excluded
[1] Brushed Aluminium	GU5,3	0001083	42,00 €
[2] White	GU5,3	0001085	42,00 €
NOTE	Transformer not included		

ACCESSORIES		CODE	UNIT PRICE vat excluded
Electronic Ballast 12V 5-70W halogen lamp 2,5-50W LED lamp		8000142	58,00 €
Concrete Form		8000110	50,00 €
Wiring Kit GZ10		8000159	20,00 €

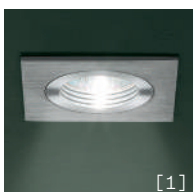





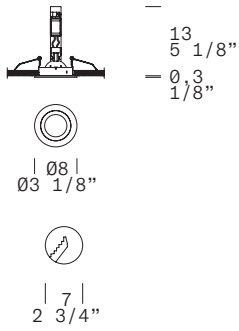

**SD 803 I - INDOOR**  
Leucos Design Lab, 2004



**TECHNICAL SHEET**

<b>MATERIALS</b>	Diffuser: Metal Structure: Metal
<b>DIMENSIONS</b>	Diffuser: 8cm h0,3cm [3 1/8" h 1/8"]
<b>FINISHES (DIFFUSER + STRUCTURE)</b>	[1] Brushed Aluminium [2] White
	 [1]  [2]
<b>LIGHT SOURCE</b>	GU5,3 1 x 8W Retrofit LED (1 x max 50W Halogen Bulb)
<b>MARKING</b>	DRY LOCATION   
<b>PACKAGING</b>	Gross weight: 0,5kg - 0,001m <sup>3</sup> Dimensions: 13,5x10x7cm



**PRICE LIST**



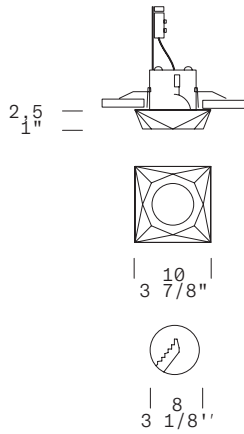

FINISH	SOURCE	CODE	UNIT PRICE vat excluded
[1] Brushed Aluminium	GU5,3	0001087	40,00 €
[2] White	GU5,3	0001089	40,00 €
<b>NOTE</b>	Transformer not included		
ACCESSORIES		CODE	UNIT PRICE vat excluded
Electronic Ballast 12V 5-70W halogen lamp 2,5-50W LED lamp		8000142	58,00 €
Concrete Form		8000110	50,00 €
Wiring Kit GZ10		8000159	20,00 €

**SIDERAL I - INDOOR**

Mauro Marzollo, 2001



TECHNICAL SHEET

MATERIALS	Diffuser: Glass Structure: Metal
DIMENSIONS	Diffuser: 10cm h2,5cm [Ø3 7/8" h1"]
FINISHES (DIFFUSER + STRUCTURE)	[1] Crystal + White 
LIGHT SOURCE	GU5,3 1 x 8W Retrofit LED (1 x max 50W Halogen Bulb)
MARKING	DRY LOCATION   
PACKAGING	Gross weight: 1kg - 0,002m³ Dimensions: 12x12x12,5cm

PRICE LIST







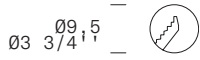
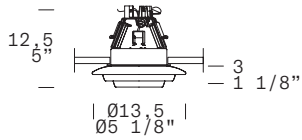

FINISH	SOURCE	CODE	UNIT PRICE vat excluded
Crystal + White	GU5,3	0002252	99,00 €
NOTE	Transformer not included		
ACCESSORIES		CODE	UNIT PRICE vat excluded
Electronic Ballast 12V 5-70W halogen lamp 2,5-50W LED lamp		8000142	58,00 €

**SUN I - INDOOR**

Toso, Massari & Associates Pamio, 1998



**TECHNICAL SHEET**

<b>MATERIALS</b>	Diffuser: Glass Structure: Metal
<b>DIMENSIONS</b>	Diffuser: Ø13,5cm h3cm [Ø5 1/8" h1 1/8"]
<b>FINISHES (DIFFUSER + STRUCTURE)</b>	[1] Crystal + Chrome [2] Satin White + Chrome
	 [1]
	 [2]
<b>LIGHT SOURCE</b>	GU5,3 1 x 8W Retrofit LED (1 X max 50W Halogen Bulb) GU10 1 x 50W Halogen Bulb
<b>MARKING</b>	GU5,3: DRY LOCATION    GU10: DRY LOCATION   
<b>PACKAGING</b>	Gross weight: 0,58kg - 0,008m³ Dimensions: 30x17x14cm



[2]



[1]

**PRICE LIST**

FINISH	SOURCE	CODE	UNIT PRICE vat excluded
[1] Crystal + Chrome	GU5,3	0004486	149,00 €
[2] Satin White + Chrome	GU5,3	0004487	158,00 €
<b>ACCESSORIES</b>	Electronic Ballast 12V*	8000142	58,00 €
<b>NOTE</b>	Transformer not included *5-70W halogen lamp/2,5-50W LED lamp		
FINISH	SOURCE	CODE	UNIT PRICE vat excluded
[1] Crystal + Chrome	GU10	0004488	158,00 €
[2] Satin White + Chrome	GU10	0004489	169,00 €

**VAN 2 I - INDOOR**  
Robeto Pamio, 1991

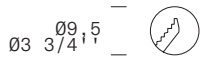
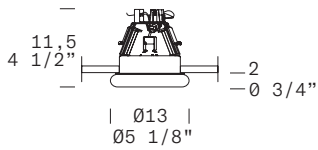

TECHNICAL SHEET

MATERIALS	Diffuser: Glass Structure: Metal
DIMENSIONS	Diffuser: Ø13,5cm h4,5cm [Ø5 1/4" h1 3/4"]
FINISHES (DIFFUSER + STRUCTURE)	[1] Crystal + Chrome [2] Satin White + Chrome
	[1]
	[2]
LIGHT SOURCE	GU5,3 1 x 8W Retrofit LED (1 X max 50W Halogen Bulb) GU10 1 x 50W Halogen Bulb
MARKING	GU5,3: DRY LOCATION GU10: DRY LOCATION
PACKAGING	Gross weight: 0,89kg - 0,008m³ Dimensions: 30x17x14cm



PRICE LIST

FINISH	SOURCE	CODE	UNIT PRICE vat excluded
[1] Crystal + Chrome	GU5,3	0004277	139,00 €
[2] Satin White + Chrome	GU5,3	0004276	139,00 €
ACCESSORIES	Electronic Ballast 12V*	8000142	58,00 €
NOTE	Transformer not included *5-70W halogen lamp/2,5-50W LED lamp		
FINISH	SOURCE	CODE	UNIT PRICE vat excluded
[1] Crystal + Chrome	GU10	0004279	142,00 €
[2] Satin White + Chrome	GU10	0004278	141,00 €



EN ACCESSORIES

IT ACCESSORI

## ELECTRONIC BALLASTS AND TRANSFORMERS/ALIMENTATORI E TRASFORMATORI ELETTRONICI

	accessories	code	price VAT excluded
electronic ballast/alimentatore elettronico	electronic transformer 12V/trasformatore elettronico 12V 5-70W halogen lamp / 2,5-50W LED lamp	8000142	58,00 €

## KIT

	accessories	code	price VAT excluded
off centre kit 1/kit 1 per decentramento	kit 1 per decentramento cromato	8000150	20,00
	off centre kit 1 brushed nickel/kit 1 per decentramento nickel satinato	8000151	20,00

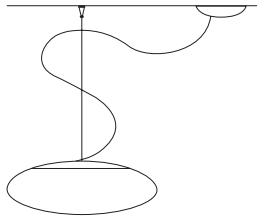
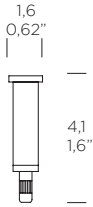

off centre kit 2/kit 2 per decentramento	off centre kit 2 brushed nickel/kit 2 per decentramento nickel satinato	8000136	99,00 €
	off centre kit 2 chrome/kit 2 per decentramento cromato	8000135	108,00

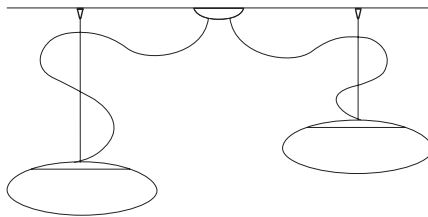
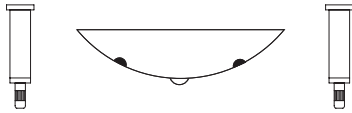

off centre kit 3/kit 3 per decentramento	off centre kit 3 chrome/kit 3 per decentramento cromato	8000152	20,00 €
	off centre kit 3 gold/kit 3 per decentramento dorato	8000137	20,00 €
	off centre kit 3 brushed nickel/kit 3 per decentramento nickel satinato	8000153	20,00 €

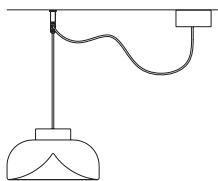
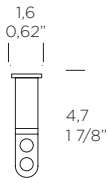

off centre kit 4/kit 4 per decentramento	off centre kit 4 chrome/kit 4 per decentramento cromato	8000154	30,00 €
	off centre kit 4 brushed nickel/kit 4 per decentramento nickel satinato	8000155	30,00 €

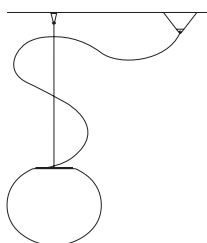
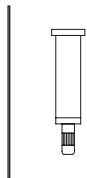

wiring kit/kit cablaggio	wiring kit/kit cablaggio GZ10 for downlights SD 802 ÷ 903	8000159	20,00 €
--------------------------	---	---------	---------

compatible bulbs (not included):  
lampadine compatibili (non include):



1x50W GZ 10



1x11W GU 10 MEGAMAN



1x7W GU 10 MASTERLED

<b>BOHEME L8-L12</b>	<b>accessories</b>	<b>code</b>	<b>price VAT excluded</b>
chain/ <i>catena</i> BOHEME L8-L12	chromed chain/ <i>catena cromata</i> cm100 - 39 3/8"	8000027	40,00 €

<b>SD-802-803</b>			<b>price VAT excluded</b>
downlights mounting box	concrete form for SD 802-803 <i>cassaforma per SD 802-803</i>	8000110	50,00 €

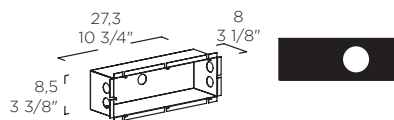

LEUCOS code	GTIN (EAN code)	Product Name
0011532	8052011012956	AELLA S 54 LED-TRANSPARENT-GLOSSY CHROME-3000K (0-10V - push - Dali)
0011565	8052011012963	AELLA S 54 LED-TRANSPARENT-GLOSSY WARM WHITE-3000K (0-10V - push - Dali)
0011998	8052011012970	AELLA S 54 LED-SMOKE GREY-VINTAGE BRASS-3000K (0-10V - push - Dali)
0012000	8052011012987	AELLA S 54 LED-SMOKE GREY-MATTE GUNMETAL-3000K (0-10V - push - Dali)
0011500	8052011012994	AELLA S 54 LED-TRANSPARENT-GLOSSY CHROME-2700K (0-10V - push - Dali)
0011559	8052011013007	AELLA S 54 LED-TRANSPARENT-GLOSSY WARM WHITE-2700K (0-10V - push - Dali)
0012004	8052011013014	AELLA S 54 LED-SMOKE GREY-VINTAGE BRASS-2700K (0-10V - push - Dali)
0012006	8052011013021	AELLA S 54 LED-SMOKE GREY-MATTE GUNMETAL-2700K (0-10V - push - Dali)
0012187	8052011014035	AELLA S 54 LED - Transparent-Glossy Chrome - 3000K - Phase cut
0012191	8052011014042	AELLA S 54 LED - Transparent-Glossy Chrome - 2700K - Phase cut
0012188	8052011014059	AELLA S 54 LED - Transparent-Glossy Warm White - 3000K - Phase cut
0012192	8052011014066	AELLA S 54 LED - Transparent-Glossy Warm White - 2700K - Phase cut
0012190	8052011014073	AELLA S 54 LED - Smoke Grey-Matte Gunmetal - 3000K - Phase cut
0012194	8052011014080	AELLA S 54 LED - Smoke Grey-Matte Gunmetal - 2700K - Phase cut
0012202	8052011014097	AELLA S 54 LED - Transparent-Vintage Brass - 3000K- Phase cut
0012201	8052011014103	AELLA S 54 LED - Transparent-Vintage Brass - 2700K - Phase cut
0008879	8052011014110	AELLA MINI S 30 LED - Transparent-Glossy Chrome - 2700K - Phase cut
0012199	8052011014127	AELLA MINI S 30 LED - Transparent-Glossy Warm White - 2700K - Phase cut
0008939	8052011014134	AELLA MINI S 30 LED - Smoke Grey-Glossy Gunmetal - 2700K - Phase cut
0011467	8052011012284	AURELIA S 45 LED-TRANSPARENT-VINTAGE BRASS-3000K (0-10V - push)
0011468	8052011012291	AURELIA S 45 LED-TRANSPARENT-MATTE GUNMETAL-3000K (0-10V - push)
0011469	8052011012307	AURELIA S 45 LED-TRANSP-GLOSSY WARM WHITE-3000K (0-10V - push)
0011473	8052011012314	AURELIA S 45 LED-SMOKE GREY-VINTAGE BRASS-3000K (0-10V - push)
0011474	8052011012321	AURELIA S 45 LED-SMOKE GREY-MATTE GUNMETAL-3000K (0-10V - push)
0011475	8052011012338	AURELIA S 45 LED-SMOKE GREY-GLOSSY WARM WHITE-3000k (0-10V - push)
0011479	8052011012345	AURELIA S 45 LED-TRANSPARENT-VINTAGE BRASS-2700K (0-10V - push)
0011481	8052011012352	AURELIA S 45 LED-TRANSPARENT-MATTE GUNMETAL-2700K (0-10V - push)
0011483	8052011012369	AURELIA S 45 LED-TRANSPARENT-GLOSSY WARM WHITE-2700K (0-10V - push)
0011485	8052011012376	AURELIA S 45 LED-SMOKE GREY-VINTAGE BRASS-2700K (0-10V - push)
0011487	8052011012383	AURELIA S 45 LED-SMOKE GREY-MATTE GUNMETAL-2700K (0-10V - push)
0011489	8052011012390	AURELIA S 45 LED-SMOKE GREY-GLOSSY WARM WHITE-2700K (0-10V - push)
0012042	8052011012406	AURELIA S 45 LED-TRANSPARENT-VINTAGE BRASS-3000K (phase cut)
0012043	8052011012413	AURELIA S 45 LED-TRANSPARENT-MATTE GUNMETAL-3000K (phase cut)
0012044	8052011012420	AURELIA S 45 LED-TRANSPARENT-GLOSSY WARM WHITE-3000k (phase cut)
0012045	8052011012437	AURELIA S 45 LED-SMOKE GREY-VINTAGE BRASS-3000K (phase cut)
0012046	8052011012444	AURELIA S 45 LED-SMOKE GREY-MATTE GUNMETAL-3000K (phase cut)
0012047	8052011012451	AURELIA S 45 LED-SMOKE GREY-GLOSSY WARM WHITE-3000k (phase cut)
0012048	8052011012468	AURELIA S 45 LED-TRANSPARENT-VINTAGE BRASS-2700K (phase cut)
0012049	8052011012475	AURELIA S 45 LED-TRANSPARENT-MATTE GUNMETAL-2700K (phase cut)
0012050	8052011012482	AURELIA S 45 LED-TRANSPARENT-GLOSSY WARM WHITE-2700K (phase cut)
0012051	8052011012499	AURELIA S 45 LED-SMOKE GREY-VINTAGE BRASS-2700K (phase cut)
0012052	8052011012505	AURELIA S 45 LED-SMOKE GREY-MATTE GUNMETAL-2700K (phase cut)
0012053	8052011012512	AURELIA S 45 LED-SMOKE FUME-GLOSSY WARM WHITE-2700K (phase cut)
0011491	8052011012529	AURELIA BOLD S 22 LED-TRANSP-VINTAGE BRASS-3000K (0-10V - push)
0011493	8052011012536	AURELIA BOLD S 22 LED-TRANSP-MATTE GUNMETAL-3000K (0-10V - push)
0011495	8052011012543	AURELIA BOLD S 22 LED-TRANSP-GLOSSY WARM WHITE-3000K (0-10V - push)
0011497	8052011012550	AURELIA BOLD S 22 LED-SMOKE GREY-VINTAGE BRASS-3000K (0-10V - push)
0011499	8052011012567	AURELIA BOLD S 22 LED-SMOKE GREY-MATT GUNMETAL-3000K (0-10V - push)
0011501	8052011012574	AURELIA BOLD S 22 LED-SMOKE GREY-GLOSSY WARM WHITE-3000K (0-10V - push)
0011503	8052011012581	AURELIA BOLD S 22 LED-TRANSP-VINTAGE BRASS-2700K (0-10V - push)
0011505	8052011012598	AURELIA BOLD S 22 LED-TRANSP-MATTE GUNMETAL-2700K (0-10V - push)
0011507	8052011012604	AURELIA BOLD S 22 LED-TRANSP-GLOSSY WARM WHITE-2700K (0-10V - push)
0011509	8052011012611	AURELIA BOLD S 22 LED-SMOKE GREY-VINTAGE BRASS-2700K (0-10V - push)
0011511	8052011012628	AURELIA BOLD S 22 LED-SMOKE GREY-MATT GUNMETAL-2700K (0-10V - push)
0011513	8052011012635	AURELIA BOLD S 22 LED-SMOKE-GLOSSY WARM WHITE-2700K (0-10V - push)
0012054	8052011012642	AURELIA BOLD S 22 LED-TRANSP-VINTAGE BRASS-3000K (phase cut)
0012055	8052011012659	AURELIA BOLD S 22 LED-TRANSP-MATTE GUNMETAL-3000K (phase cut)
0012056	8052011012666	AURELIA BOLD S 22 LED-TRANSP-GLOSS WARM WHITE-3000K (phase cut)
0012057	8052011012673	AURELIA BOLD S 22 LED-SMOKE GREY-VINTAGE BRAS-3000K (phase cut)
0012058	8052011012680	AURELIA BOLD S 22 LED-SMOKE GREY-MATT GUNMETAL-3000K (phase cut)
0012059	8052011012697	AURELIA BOLD S 22 LED-SMOKE GREY-GLOSSY WARM WHITE-3000K (phase cut)
0012060	8052011012703	AURELIA BOLD S 22 LED-TRANSP-VINTAGE BRASS-2700K (phase cut)
0012061	8052011012710	AURELIA BOLD S 22 LED-TRANSP-MATTE GUNMETAL-2700K (phase cut)
0012062	8052011012727	AURELIA BOLD S 22 LED-TRANSP-GLOSSY WARM WHITE-2700K (phase cut)
0012063	8052011012734	AURELIA BOLD S 22 LED-SMOKE GREY-VINTAGE BRASS-2700K (phase cut)
0012064	8052011012741	AURELIA BOLD S 22 LED-SMOKE GREY-MATT GUNMETAL-2700K (phase cut)
0012065	8052011012758	AURELIA BOLD S 22 LED-SMOKE GREY-GLOSSY WARM WHITE-2700K (phase cut)



LEUCOS code	GTIN (EAN code)	Product Name
0000781	8052011015865	BOHEME L 8 - E14 - Trasparent/Chrome
0000782	8052011015872	BOHEME L 8 - E14 - Smoke Grey/Chrome
0000784	8052011015889	BOHEME L 12 - E14 - Trasparent/Chrome
0000785	8052011015896	BOHEME L 12 - E14 - Smoke Grey/Chrome
0010070	8052011014141	ETHER S - GU10 Retrofit LED
0010064	8052011014158	ETHER S 90 - G53 Retrofit LED
0010065	8052011014165	ETHER S 90 - G53 Retrofit LED + GU5,3 Retrofit LED RGB
0010060	8052011014172	ETHER S 150 - G53 Retrofit LED
0010061	8052011014189	ETHER S 150 - G53 Retrofit LED + GU5,3 Retrofit LED RGB
0002821	8052011014219	GLO INCASSO I - H 85 cm - White Sfumato - Chrome
0002824	8052011014226	GLO INCASSO I - H 85 cm - Red-Chrome
0002827	8052011014233	GLO INCASSO I - H 85cm - Acquamarine-Chrome
0002984	8052011014240	GLO INCASSO I - H 150 cm - White Sfumato - Chrome
0002988	8052011014257	GLO INCASSO I - H 150 cm - Red-Chrome
0002992	8052011014264	GLO INCASSO I - H 150 cm - Acquamarine-Chrome
0002904	8052011014271	GLO INCASSO I - H 210 cm - White Sfumato - Chrome
0002907	8052011014288	GLO INCASSO I - H 210 cm - Red-Chrome
0002910	8052011014295	GLO INCASSO I - H 210 cm - Acquamarine-Chrome
0002928	8052011014301	GLO INCASSO I - H 270 cm - White Sfumato - Chrome
0002932	8052011014318	GLO INCASSO I - H 270 cm - Red-Chrome
0002936	8052011014325	GLO INCASSO I - H 270 cm - Acquamarine-Chrome
0003114	8052011014332	GLO S - H 85 cm - White Sfumato - Chrome
0003116	8052011014349	GLO S - H 85 cm - Red - Chrome
0003118	8052011014356	GLO S - H 85 cm - Acquamarine-Chrome
0003159	8052011014363	GLO S - H 150 cm - White Sfumato - Chrome
0003162	8052011014370	GLO S - H 150 cm - Red - Chrome
0003165	8052011014387	GLO S - H 150 cm - Acquamarine-Chrome
0003187	8052011014394	GLO S - H 210 cm - White Sfumato - Chrome
0003189	8052011014400	GLO S - H 210 cm - Red - Chrome
0003191	8052011014417	GLO S - H 210 cm - Acquamarine-Chrome
0003400	8052011014424	GLO S - H 270 cm - White Sfumato - Chrome
0003403	8052011014431	GLO S - H 270 cm - Red - Chrome
0003406	8052011014448	GLO S - H 270 cm - Acquamarine-Chrome
0003424	8052011014455	GLO S/I - H 85 cm - White Sfumato - Chrome
0003427	8052011014462	GLO S/I - H 85 cm - Red - Chrome
0003430	8052011014479	GLO S/I - H 85 cm - Acquamarine-Chrome
0003460	8052011014486	GLO S/I - H 150 cm - White Sfumato - Chrome
0003463	8052011014493	GLO S/I - H 150 cm - Red - Chrome
0003466	8052011014509	GLO S/I - H 150 cm - Acquamarine-Chrome
0003496	8052011014516	GLO S/I - H 210 cm - White Sfumato - Chrome
0003499	8052011014523	GLO S/I - H 210 cm - Red - Chrome
0003502	8052011014530	GLO S/I - H 210 cm - Acquamarine-Chrome
0003532	8052011014547	GLO S/I - H 270 cm - White Sfumato - Chrome
0003535	8052011014554	GLO S/I - H 270 cm - Red - Chrome
0003538	8052011014561	GLO S/I - H 270 cm - Acquamarine-Chrome
0002304	8052011014196	KEYRA S 30 LED -Transparent/Satin White-Glossy White - 3000K
0002306	8052011014202	KEYRA S 60 LED -Transparent/Satin White-Glossy White - 3000K
0011514	8052011012765	LIGHTBODY S E27
0011515	8052011012772	LIGHTBODY BOLD S E27
0000083	8052011014578	LILITH S 40 - Silver-Brushed Nickel
0000089	8052011014585	LILITH S 40 - White-Brushed Nickel
0000106	8052011014592	LILITH S 40 - Mocha-Brushed Nickel
0000084	8052011014608	LILITH S 55 - Silver-Brushed Nickel
0000090	8052011014615	LILITH S 55 - White-Brushed Nickel
0000107	8052011014622	LILITH S 55 - Mocha-Brushed Nickel
0000121	8052011014639	LILITH S 70 - Silver-Brushed Nickel
0000125	8052011014646	LILITH S 70 - White-Brushed Nickel
0000136	8052011014653	LILITH S 70 - Mocha-Brushed Nickel
0004437	8052011014660	VOLTA S 160 LED - Satin Methacrylate-Matte White -2700K
0008315	8052011014677	VOLTA S 160 LED - Satin Methacrylate-Textured Black RAL9004 -2700K

LEUCOS code	GTIN (EAN code)	Product Name
0012209	8052011014806	ALIAS P 15 LED - Gloss Methacrylate-White
0012207	8052011014813	ALIAS P 15 LED - Gloss Methacrylate-Chrome
0012247	8052011014820	ALIAS P 15 LED - Gloss Methacrylate-Brushed Brass
0012210	8052011014837	ALIAS P 35 LED - Gloss Methacrylate-White
0012208	8052011014844	ALIAS P 35 LED - Gloss Methacrylate-Chrome
0012251	8052011014851	ALIAS P 35 LED - Gloss Methacrylate-Brushed Brass
0012216	8052011014868	BETA SMALL P-PL LED - Gloss White (Off) shaded of sand (On) / Satin Steel
0012217	8052011014875	BETA SMALL P-PL LED - Gloss White (Off) shaded of sand (On) / Satin Steel
0002709	8052011014882	BETA BIG P-PL - Gloss White (Off) shaded of sand (On) / Satin Steel
0003805	8052011014899	CELINE P (E27) - Satin White - Brushed Nickel
0012212	8052011014905	CELINE P LED - Satin White - Brushed Nickel - 3000K - Push-dim; 0/1-10V
0012235	8052011014912	CELINE P LED - Satin White - Brushed Nickel - 2700K - Push-dim; 0/1-10V
0012213	8052011014929	CELINE P LED - Satin White - Brushed Nickel - 3000K - Phase cut
0012237	8052011014936	CELINE P LED - Satin White - Brushed Nickel - 2700K - Phase cut
0003955	8052011014943	CELINE P 35 (E27) - Satin White - Brushed Nickel
0012214	8052011014950	CELINE P 35 LED - Satin White - Brushed Nickel - 3000K - Push-dim; 0/1-10V
0012239	8052011014967	CELINE P 35 LED - Satin White - Brushed Nickel - 2700K - Push-dim; 0/1-10V
0012215	8052011014974	CELINE P 35 LED - Satin White - Brushed Nickel - 3000K - Phase cut
0012241	8052011014981	CELINE P 35 LED - Satin White - Brushed Nickel - 2700K - Phase cut
0001710	8052011014998	CUBI P-PL 11 (G9) - Satin White-Grey
0001712	8052011015001	CUBI P-PL 11 LED - Satin White-Grey - 3000K - IP20
0011040	8052011015018	CUBI P-PL 11 LED - Satin White-Brushed Brass - 3000K - IP20
0001787	8052011015025	CUBI P-PL 11 LED - Satin White-Grey - 2700K - IP20
0011042	8052011015032	CUBI P-PL 11 LED - Satin White-Brushed Brass - 2700K - IP20
0001785	8052011015049	CUBI P-PL 11 LED - Satin White-Grey - 2700K - IP44
0011041	8052011015056	CUBI P-PL 11 LED - Satin White-Brushed Brass - 2700K - IP44
0001670	8052011015063	CUBI P-PL 16 (G9) - Satin White-Grey
0001671	8052011015070	CUBI P-PL 16 LED - Satin White-Grey - 3000K - IP20
0011049	8052011015087	CUBI P-PL 16 LED - Satin White-Brushed Brass - 3000K - IP20
0001788	8052011015094	CUBI P-PL 16 LED - Satin White-Grey - 2700K - IP20
0011051	8052011015100	CUBI P-PL 16 LED - Satin White-Brushed Brass - 2700K - IP20
0001786	8052011015117	CUBI P-PL 16 LED - Satin White-Grey - 2700K - IP44
0011050	8052011015124	CUBI P-PL 16 LED - Satin White-Brushed Brass - 2700K - IP44
0001709	8052011015131	CUBI P-PL 28 (E14) - Satin White-Grey
0001804	8052011015148	CUBI P-PL 28 LED - Satin White-Grey
0012221	8052011015155	KEYRA P-PL 30 LED - Transparent/Satin White-Gloss White - 3000K - Push-dim; 0/1-10V
0012219	8052011015162	KEYRA P-PL 30 LED - Transparent/Satin White-Gloss White - 3000K - Phase-cut
0002433	8052011015179	KEYRA P-PL 60 LED - Transparent/Satin White-Gloss White - 3000K
0000006	8052011015186	LILITH PL 40 (E14) - Silver-Brushed Nickel
0000012	8052011015193	LILITH PL 40 (E14) - White-Brushed Nickel
0000029	8052011015209	LILITH PL 40 (E14) - Mocha-Brushed Nickel
0000007	8052011015216	LILITH PL 55 (E27) - Silver-Brushed Nickel
0000013	8052011015223	LILITH PL 55 (E27) - White-Brushed Nickel
0000030	8052011015230	LILITH PL 55 (E27) - Mocha-Brushed Nickel
0000039	8052011015247	LILITH PL 70 (E27) - Silver-Brushed Nickel
0000043	8052011015254	LILITH PL 70 (E27) - White-Brushed Nickel
0000054	8052011015261	LILITH PL 70 (E27) - Mocha-Brushed Nickel
0000538	8052011015278	PASCALE P - G9 - Crystal-Chrome
0000410	8052011015285	PASCALE PL 30 - G9 - Crystal-Chrome
0000385	8052011015292	PASCALE PL 40 - E14 - Crystal-Chrome
0003727	8052011015308	PLANET P-PL 32 LED - Satin White-Chrome - 3000K
0003749	8052011015315	PLANET P-PL 48 (G9) - Satin White-Chrome
0003751	8052011015322	PLANET P-PL 48 LED - Satin White-Chrome - 3000K
0003754	8052011015339	PLANET P-PL 65 (G9) - Satin White-Chrome
0003756	8052011015346	PLANET P-PL 65 LED - Satin White-Chrome - 3000K
0003935	8052011015353	VITTORIA P 2 (R7s 80mm) - Satin White-Chrome
0003937	8052011015360	VITTORIA P 2 LED - Satin White-Chrome - 3000K

LEUCOS code	GTIN (EAN code)	Product Name
0012024	8052011012802	AELLA T 54 E27-TRANSPARENT-GLOSSY WARM WHITE
0012026	8052011012819	AELLA T 54 E27-SMOKE GREY-VINTAGE BRASS
0012027	8052011012826	AELLA T 54 E27-SMOKE GREY-MATTE GUNMETAL
0012029	8052011012833	AELLA T 54 E27-SMOKE GREY-RAW BRASS
0012030	8052011012840	AELLA T 54 E27-TRANSPARENT-GLOSSY CHROME
0011573	8052011012857	AELLA T 54 LED-TRANSPARENT-GLOSSY CHROME-3000K
0011542	8052011012864	AELLA T 54 LED-TRANSPARENT-GLOSSY WARM WHITE-3000K
0011528	8052011012871	AELLA T 54 LED-SMOKE GREY-VINTAGE BRASS-3000K
0011530	8052011012888	AELLA T 54 LED-SMOKE GREY-MATTE GUNMETAL-3000K
0011551	8052011012895	AELLA T 54 LED-SMOKE GREY-RAW BRASS-3000K
0011567	8052011012901	AELLA T 54 LED-TRANSPARENT-GLOSSY CHROME-2700K
0011538	8052011012918	AELLA T 54 LED-TRANSPARENT-GLOSSY WARM WHITE-2700K
0011496	8052011012925	AELLA T 54 LED-SMOKE GREY-VINTAGE BRASS-2700K
0011498	8052011012932	AELLA T 54 LED-SMOKE GREY-MATTE GUNMETAL-2700K
0011547	8052011012949	AELLA T 54 LED-SMOKE GREY-RAW BRASS-2700K
0008713	8052011014684	AELLA MINI T 30 LED - Transparent-Glossy Chrome
0012197	8052011014691	AELLA MINI T 30 LED - Transparent-Glossy Warm White
0008913	8052011014707	AELLA MINI T 30 LED - Smoke Grey-Glossy Gunmetal
0012195	8052011014714	LIGHTBODY T (E27) - On/Off - Transparent
0012196	8052011014721	LIGHTBODY T (E27) - Dimmer on cord - Transparent
0011516	8052011012789	LIGHTBODY BOLD T - E27-On/Off - Transparent
0011517	8052011012796	LIGHTBODY BOLD T - E27- Dimmer on cord - Transparent
0002524	8052011014738	PARALUME MINI T - Satin White-White
0002523	8052011014745	PARALUME P (SMALL) T - Satin White-White
0002516	8052011014752	PARALUME M (MEDIUM) T - Satin White-White
0002514	8052011014769	PARALUME G (BIG) T - Satin White-White
0004078	8052011015841	SPHERA T3/29 - E27 - Satin white/Chrome
0011058	8052011015919	SPHERA T3/29 - E27 - Satin white/Brushed Brass
0004081	8052011015858	SPHERA T3/37 - E27 - Satin white/Chrome
0011059	8052011015926	SPHERA T3/37 - E27 - Satin white/Brushed Brass
0004062	8052011015933	SPHERA T3/45 - E27 - Satin white/Chrome
0011060	8052011015940	SPHERA T3/45 - E27 - Satin white/Brushed Brass
0004096	8052011014776	STACKING B TR - Smoke Grey, White, Smoke Grey, White, Mirror / Chrome"
0004098	8052011014783	STACKING C TR - Smoke Grey,White,Amber,Tobacco,White,Amber / Gold"
0004100	8052011014790	STACKING D TR - White,Gold,Transparent Tobacco,White,Gold,Black / Gold
0004253	8052011015377	DROP I - GU5,3 - Crystal-Chrome
0004252	8052011015384	DROP I - GU5,3 - Satin White-Chrome
0004255	8052011015391	DROP I - GU10 - Crystal-Chrome
0004254	8052011015407	DROP I - GU10 - Satin White-Chrome
0004261	8052011015414	ISIDE 2 I - GU5,3 - Crystal-Chrome
0004260	8052011015421	ISIDE 2 I - GU5,3 - Satin White-Chrome
0004263	8052011015438	ISIDE 2 I - GU10 - Crystal-Chrome
0004262	8052011015445	ISIDE 2 I - GU10 - Satin White-Chrome
0002844	8052011015452	MIRA 2 I - GU5,3 - Crystal-Chrome
0002846	8052011015469	MIRA 2 I - GU5,3 - Satin White-Chrome
0002845	8052011015476	MIRA 2 I - GU10 - Crystal-Chrome
0002847	8052011015483	MIRA 2 I - GU10 - Satin White-Chrome
0004486	8052011015490	SUN I - GU5,3 - Crystal-Chrome
0004487	8052011015506	SUN I - GU5,3 - Satin White-Chrome
0004488	8052011015513	SUN I - GU10 - Crystal-Chrome
0004489	8052011015520	SUN I - GU10 - Satin White-Chrome
0004277	8052011015537	VAN 2 I - GU5,3 - Crystal-Chrome
0004276	8052011015544	VAN 2 I - GU5,3 - Satin White-Chrome
0004279	8052011015551	VAN 2 I - GU10 - Crystal-Chrome
0004278	8052011015568	VAN 2 I - GU10 - Satin White-Chrome
0000313	8052011015575	PEGASO I - GU5,3 - Transparent Graniglia-White
0000315	8052011015582	PEGASO I - GU5,3 - Amber Graniglia-White
0002252	8052011015599	SIDERAL I - GU5,3 - Crystal-White
0001083	8052011015605	SD 802 I - GU5,3 - Brushed Aluminium
0001085	8052011015612	SD 802 I - GU5,3 - White
0001087	8052011015629	SD 803 I - GU5,3 - Brushed Aluminium
0001089	8052011015636	SD 803 I - GU5,3 - White

LEUCOS code	GTIN (EAN code)	Product Name
8000243	8052011015674	kit 4 metal flanges for bulb for LED G53 ETHER S 90/150
8000142	8052011015681	Electronic transformer 50W 12V
8000150	8052011015698	Off centre kit 1 chrome
8000151	8052011015704	Off centre kit 1 brushed nickel
8000136	8052011015711	Off centre kit 2 brushed nickel
8000135	8052011015728	Off centre kit 2 chrome
8000152	8052011015735	Off centre kit 3 chrome
8000137	8052011015742	Off centre kit 3 gold
8000153	8052011015759	Off centre kit 3 brushed nickel
8000154	8052011015766	Off centre kit 4 chrome
8000155	8052011015773	Off centre kit 4 brushed nickel
8000159	8052011015780	Wiring kit GZ10 for downlights SD 802 ÷ 903
8000110	8052011015797	Concrete form for SD 802-803
8000027	8052011015902	BOHEME ACCESSORIES - Chromed chain cm 100 to extended



**ETHER**

Patrick Jouin, 2006



- 1 Bodegas Alion Of Penafield, Valladolid, Spain  
Credits: Fernando Manteca
- 2 Mix Restaurant, Las Vegas, USA  
Architect: Jouin Manku Studio  
Credits: Eric Laignel
- 3 Van Cleef & Arpels, Paris, France  
Architect: Jouin Manku Studio  
Credits: Eric Laignel
- 4 YTL Residence, Kuala Lumpur, Malaisie  
Architect: Jouin Manku Studio  
Credits: Eric Laignel

## TERMS AND CONDITIONS OF SALE

### CERTIFICATIONS AND TRADE MARKS

Our lighting fixtures are wired according to Class I specifications. Additional safety precautions against electric shocks are provided besides the insulation of the incoming feeder. All touchable metal components are connected to the grounding. Fixtures wired according to Class II are provided with double insulation, without grounding, while the Class III ones are safe because of the low voltage. High thermic resistance wires are used and halogen bulbs are fitted with glass protector. Epoxidic powders lacquering to guarantee perfect scratch resistance. For easier cleaning of glass diffusers some lukewarm water with vinegar is recommended.

### GENERAL INFORMATIONS

LEUCOS reserves the right to modify at any time without notice the technical and aesthetic characteristics of the elements printed in this price list. The colours shown in the price list are an indication only. Regardless of the patent protection, designs and patterns produced by LEUCOS and reported in this price list are protected by copyright. The registered brands quoted in the price list are the exclusive property of their respective owners. All technical details referring to the Retrofit LED 'wattage' are an indication only. Due to the ever-changing improvements of technology, Leucos reserves the right to update both the list of available products and their technical characteristics. It is forbidden to reproduce any part of this price list.

### ART. 1 - GENERAL ASPECTS

1.1 The terms and conditions set out hereunder (the "LEUCOS General Terms and Conditions of Sale") are an integral part of the offers and/or proposals made by Leucos (hereinafter "Seller") and of the contracts concluded between Seller and any purchaser (hereinafter "Purchaser") concerning the sale of lighting devices and components, available in the collections bearing the LEUCOS trademark and included in the related catalog, as created and modified from time to time (hereinafter the "Products").

1.2 The LEUCOS General Terms and Conditions of Sale shall apply to all transactions concluded between Seller and Purchaser, without the need for an express reference thereto or for a specific agreement to this effect upon the conclusion of each transaction. All other terms and conditions shall only apply where confirmed in writing by Seller.

1.3 Seller reserves the right to amend, add to or vary the LEUCOS General Terms and Conditions of Sale, appending such variations to the offers or any correspondence sent to Purchaser in writing.

### ART. 2 - PRODUCT AVAILABILITY

2.1 Purchaser is aware and accepts that the Products shall be solely those available when the contract is concluded and/or the order is confirmed by Seller.

2.2 Seller reserves the right not to fill an order if the Products can no longer be manufactured or supplied for any reason.

### ART. 3 - CONCLUSION OF THE CONTRACT

3.1 Contracts governing the supply of Products shall be considered concluded when Purchaser receives confirmation of its order from Seller.

3.2 Orders and order confirmations must be drafted in written form and signed by Purchaser and may also be sent by fax or e-mail.

3.3 If an order is preceded by an offer by Seller, Purchaser must refer thereto for the issue of the order, it being understood, in any event, that the terms and conditions of supply specified in the offer shall become binding for Seller only if, and to the extent that, the order is subsequently confirmed by Seller in writing.

3.4 Orders and/or modifications of orders made orally or over the telephone shall be confirmed in writing by Purchaser, which shall then receive the pertinent order confirmation from Seller. If

this does not occur, Seller assumes no liability for any errors or possible misunderstandings.

3.5 Purchaser shall be liable for the costs of any modifications or transformations to be applied to the Products, where possible.

3.6 Where the purchase and sale contracts provide for multiple deliveries over time, Seller reserves the right to make all modifications of an aesthetic, size and technical nature to the Products that prove necessary or appropriate, in accordance with their functional characteristics and applicable legislation, without this entitling Purchaser to make any demands or claims or any kind.

### ART. 4 - PRICES AND PAYMENTS

4.1 Unless otherwise agreed, prices are stated in euro, inclusive of packaging, but exclusive of VAT, indirect taxes, excise taxes and any taxes for which Purchaser is liable, which shall be paid by the latter. In the event of exemption, Purchaser shall provide Seller with the appropriate documentation.

4.2 Seller may modify the prices of the Products at any time as a consequence of an increase in the costs of raw materials and labor. However, the Products shall not be delivered or offered at increased prices without prior notice.

4.3 Unless otherwise agreed, payments shall be made on Seller's premises, in accordance with the agreed terms and conditions. The terms of payment shall begin to run from the date of the invoice.

4.5 In the event of agreed partial returns, the goods shall nonetheless be paid for in full. After receiving the payment from Purchaser, Seller shall issue a credit note for the return received in accordance with the same terms and conditions of payment applied to Purchaser in the contract.

### ART. 5 - NON-PAYMENT OR DELAYED PAYMENT

5.1 Payments may not be delayed and/or withheld for any reason. Any complaints or claims shall not give rise to the right to refuse payment or to offsetting.

5.2 Notwithstanding all rights granted to Seller, in the event of delayed payment or non-payment according to the agreed terms, or of refusal to accept delivery of the Products purchased, and without prejudice to rights relating to ownership:

- late payment interest shall apply, in accordance with Legislative Decree 231/2002, with effect from the date on which the payment comes due;
- Seller may suspend delivery of the Products, suspend the warranty until resumption of payment, without prejudice to the applicable due date, and allocate the sums previously received to the accounts past due;
- the acceleration clause having come into effect, Seller shall be entitled to demand immediate payment of the residual amount due.

### ART. 6 - DELIVERY TERMS

6.1 Unless otherwise agreed in writing, no delivery term indicated shall be binding for Seller. Unless otherwise agreed between the parties, delivery terms shall be indicative, as stated in the order confirmation.

6.2 Any liability relating to deliveries deriving from force majeure or other unforeseeable events - including, without limitation, those set out in ART. 12 hereunder - not attributable to Seller shall release Seller from its obligation to comply with the agreed delivery term, even if binding.

6.3 Regardless of the agreed delivery terms (carriage paid to designated port or carriage forward) and of shipping and insurance costs, delivery shall be considered to have been made, and risks transferred accordingly, in all cases and for all intents and purposes, when the goods are loaded onto the vehicle at the moment of departure from Seller's facility.

6.4 If Purchaser does not collect the Products or accept delivery thereof, Seller shall be entitled, once 15 days have elapsed from notice, and without prejudice to the legal remedies, to terminate the contract and resell the Products not collected, informing Purchaser or the terms and conditions of sale,

while definitively retaining the the advance and any installments of the price already paid by the Client, by way of penalty. The difference between the contractual price (plus the costs of storage and safekeeping) and the proceeds of resale to third parties shall be due from Client, and late payment interest shall accrue on this amount at the rate specified in ART. 5.2 a). The foregoing is without prejudice to Seller's right to compensation for any additional damages suffered.

#### ART. 7 - RETENTION OF TITLE AND TRANSFER OF RISKS

7.1 Seller shall retain title to the Products until they have been paid for in full, along with all additional costs.

7.2 Once delivery has been made, Purchaser shall be liable for all damages that the Products may suffer or cause.

7.3 Until payment in full, the Products may not be resold without Seller's prior written consent.

#### ART. 8 - WARRANTY TERMS

8.1 The Products are manufactured in accordance with applicable legislation and Seller offers a warranty for a period of 24 (twenty-four) months from the date of delivery.

8.2 All defects shall be reported according to the conditions indicated in ART. 14 below within eight (8) days of the date of delivery. In the event of latent defects, the period of eight (8) days begins when the defects are discovered.

8.3 If Purchaser is a "Consumer" as defined in ART. 3 of the Consumer Code (Legislative Decree 206/2005), any defects of conformity of the Product must be reported within two (2) months of discovery.

8.4 Seller shall not be liable for any defect in the Products due to drawings, designs or technical specifications provided by Purchaser, or for defects due to wear and tear, inappropriate or improper storage or use, negligence or unskilled use, tampering with or alteration of the Products by Purchaser or by third parties.

8.5 Seller shall not be liable for damages or losses of any kind or nature suffered by part or all of the Products during shipment, regardless of whether shipment is provided by a carrier engaged by third parties, by Purchaser or by Seller, which in this latter case renders no warranty in respect thereof, and shall be released from its delivery obligation by simply delivering the goods to the carrier.

8.6 If a complaint of flaws or defects proves to be justified, the warranty shall be limited to replacement or repair of the defective Products or components, expressly excluding any termination of the contract, reduction of the price, suspension of payment or suspension of the warranty. Replacement of the defective Products shall be at Seller's discretion, following inspection in its laboratories.

#### ART. 9 - LIMITATION OF LIABILITY

9.1 Seller shall not be liable for direct, indirect and consequential damages, without any limitation whatsoever, suffered by property or persons during the use and/or maintenance of the Products sold. In such cases, Purchaser shall hold Seller harmless and immune from any claims, actions, procedures and/or complaints by harmed third parties against Seller.

9.2 In any event, Seller's liability shall be limited to the cost of the defective products that gave rise to this liability, as quantified by the UNIT PRICE invoiced to Purchaser.

#### ART. 10 - INDUSTRIAL AND INTELLECTUAL PROPERTY RIGHTS

10.1 Trademarks, patents, designs, plans, prototypes, industrial secrets, know-how and all related industrial and intellectual property rights shall be the sole property of LEUCOS and shall remain its property ever after the sale of the Products.

10.2 Purchaser must obtain Seller's prior written permission in order to use Seller's trademarks and/or signs in its activities.

#### ART. 11 - TERMINATION

11.1 If Purchaser fails to make payment within the prescribed term or commits an ongoing or serious breach,

without remedying it within 30 (thirty) business days from the date of notice to perform sent by LEUCOS, Seller may terminate the contract immediately, without prejudice to any further rights.

11.2 In any event, LEUCOS may terminate the contract immediately in the event of a bankruptcy declaration concerning Purchaser, liquidation, suspension of payments, attachment, insolvency or any other situation that may affect performance by Purchaser.

#### ART. 12 - FORCE MAJEURE

12.1 If performance of the contract or of any other obligation (other than payment) is obstructed, limited or prevented by events of force majeure that persist for more than three (3) months, each party may terminate the contract, without any liability.

12.2 "Event of force majeure" is defined as any event that is beyond the reasonable control of the interested party, including, without limitation, strikes, lock-ins, boycotts, wars, insurrections, civil wars, acts of vandalism, compliance with laws or government orders, statutes, provisions or directives, accidents, breakdowns of plants or machinery, fires, floods, difficulties, increases in labor or shipping costs or any other circumstances capable of jeopardizing the supply of the Products.

12.3 The interested party shall inform the other party directly of the occurrence of the event of force majeure of which it has become aware and that it believes may jeopardize the performance of the contract.

#### ART. 13 - PROCESSING OF PERSONAL DATA

13.1 Purchaser's personal data shall be processed in accordance with Italian legislation governing the processing of personal data (Legislative Decree 196/2003). Seller informs Purchaser that Seller is the data controller and that Purchaser's data shall be collected and processed solely for the performance of the contract.

13.2 Refer to the privacy policy statement on the website [www.leucos.com](http://www.leucos.com) for any further information.

#### ART. 14 - COMMUNICATIONS

With the exception of information of an operational nature, all communications shall be sent in writing, by fax, registered mail with return receipt, certified e-mail (PEC) or express courier to: LEUCOS, via del Commercio 22, 36060 Romano d'Ezzelino (VI) ITALY; PEC: [clannsr@legalmail.it](mailto:clannsr@legalmail.it)

#### ART. 15 - APPLICABLE LAW AND COURT OF JURISDICTION

15.1 These LEUCOS General Terms and Conditions of Sale, all related purchase and sale contracts and all matters that derive herefrom or are related hereto, shall be governed, construed and implemented in accordance with the laws and regulations in effect in Italy, with the express exclusion of the the Vienna Convention on the International Sale of Goods 1980.

15.2 Any disputes that arise between the parties in connection with the interpretation, validity and performance of these LEUCOS General Terms and Conditions of Sale and the related contracts entered into shall come before the sole jurisdiction of the Court of Venice, to the exclusion of all other courts.

15.3 It is understood that only Seller, at its discretion, shall be entitled to waive the jurisdiction of the sole court of jurisdiction, as defined in ART. 15.2 above, in order to take legal action against Purchaser, in its domicile and before the Court with jurisdiction there.

#### ART. 16 - FINAL PROVISIONS

16.1 The rights and obligations deriving from these LEUCOS General Terms and Conditions of Sale and related purchase and sale contracts may not be assigned without Seller's prior written consent.

16.2 The invalidity of part or all of the provisions of these LEUCOS General Terms and Conditions of Sale shall not undermine the validity of the remaining provisions.

16.3 The rights and remedies of LEUCOS provided for in these LEUCOS General Terms and Conditions of Sale shall not jeopardize any other right or remedy available according to applicable law.



16.4 Any failure to exercise, or delayed exercise, by LEUCOS of its rights shall not constitute waiver or forfeiture of such rights.

16.5 Under no circumstances may the headings of the articles of these LEUCOS General Terms and Conditions be construed as limiting or extending the scope of the content of the particular sections to which they refer.

16.6 These LEUCOS General Terms and Conditions of Sale have been drafted in both Italian and English language versions. In the event of interpretative doubts, the version in Italian shall prevail.

16.7 These LEUCOS General Terms and Conditions of Sale shall enter into effect on March 29, 2019 and shall supersede previous versions.

16.8 Where justified, returns of goods must nonetheless be authorized in writing by Seller's sales office, which shall issue the instructions to be followed.

The LEUCOS General Terms and Conditions of Sale and related purchase and sale contracts may not be assigned without Seller's prior written consent.

16.9 The invalidity of part or all of the provisions of these LEUCOS General Terms and Conditions of Sale shall not undermine the validity of the remaining provisions.

Purchase to Articles 1341 and 1342 of the Italian Civil Code, Purchaser declares that it expressly approves the following clauses of the LEUCOS General Terms and Conditions of Sale: 1.3 (general aspects); 3 (conclusion of the contract); 6 (delivery terms); 8.5 - 8.6 (warranty terms); 9 (limitation of liability); 15 (applicable law and court of jurisdiction); and 16 (final provisions).

## CONDIZIONI GENERALI DI VENDITA

### CERTIFICAZIONI E MARCHI

Nei nostri apparecchi, cablati secondo le norme relative alla classe I, la protezione contro le folgorazioni si basa, oltre che sull'isolamento del cavo di alimentazione, su una misura di sicurezza supplementare, costituita dal collegamento delle parti metalliche accessibili ad un conduttore di protezione (messa a terra), in modo che tali parti non possano in ogni caso divenire pericolose. Nel caso di apparecchi cablati in classe II, la protezione viene garantita da misure di sicurezza supplementari, costituite da un doppio isolamento delle parti in tensione. Queste misure non comportano l'adozione di dispositivi per la messa a terra. Gli apparecchi appartenenti alla classe III basano la propria sicurezza sull'adozione di una tensione di alimentazione estremamente bassa. I nostri apparecchi sono corredati da cavi ad alta resistenza termica e, in ottemperanza alle norme di sicurezza contro lo scoppio delle lampadine alogene lineari, da schermi protettivi in pyrex. Le laccature sono eseguite con polveri epossidiche essicate in forni ad alta temperatura, metodo che garantisce la massima resistenza ad urti ed abrasioni. Per facilitare le normali operazioni di pulizia dei vetri, consigliamo una soluzione di acqua tiepida ed aceto.

### INFORMAZIONI GENERALI

LEUCOS si riserva la facoltà di modificare in qualunque momento e senza preavviso le caratteristiche tecniche ed estetiche degli elementi illustrati nel presente listino I colori riprodotti nel listino sono indicativi. Indipendentemente dalla tutela brevettuale, i disegni ed i modelli prodotti da LEUCOS e riportati in questo listino sono da considerarsi protetti da diritto di autore I marchi registrati in questo listino sono di esclusiva proprietà dei rispettivi proprietari I dati tecnici "wattaggio" riferiti alla sorgente Retrofit LED sono puramente indicativi Stante la continua evoluzione delle tecnologie, Leucos si riserva di aggiornare sia la lista dei prodotti disponibili che le caratteristiche tecniche degli stessi. È vietata la riproduzione anche parziale di questo listino.

### ART. 1 - ASPETTI GENERALI

1.1 I termini e le condizioni qui di seguito indicati (le "Condizioni Generali di Vendita LEUCOS") formano parte integrante delle offerte e/o proposte formulate da Leucos (di seguito "Venditore") e dei contratti conclusi tra il Venditore e qualsivoglia Acquirente (di seguito "Acquirente") riguardanti la vendita di apparecchi di illuminazione e componenti, disponibili nelle collezioni contrassegnate dal marchio LEUCOS e presenti nel relativo catalogo, di volta in volta creati e modificati (di seguito i "Prodotti").

1.2 Le Condizioni Generali di Vendita LEUCOS si applicano a tutte le transazioni concluse tra il Venditore e l'Acquirente senza necessità che vi sia un espresso richiamo alle stesse o uno specifico accordo in tal senso alla conclusione di ogni singola transazione. Qualsiasi condizione o termine differente trova applicazione soltanto se confermato per iscritto da parte del Venditore.

1.3 Il Venditore si riserva il diritto di modificare, integrare o variare le Condizioni Generali di Vendita LEUCOS, allegando tali variazioni alle offerte ovvero a qualsivoglia corrispondenza inviata per iscritto all'Acquirente.

### ART. 2 - DISPONIBILITÀ PRODOTTI

2.1 L' Acquirente è consapevole ed accetta che i Prodotti siano esclusivamente quelli disponibili al momento della conclusione del contratto e/o della conferma dell'ordine da parte del Venditore.

2.2 Il Venditore si riserva il diritto di non evadere l'ordine nel caso in cui i Prodotti non possano più, per qualunque motivo, essere fabbricati o forniti.

### ART. 3 - CONCLUSIONE DEL CONTRATTO

3.1 Il contratto avente ad oggetto la fornitura dei



Prodotti si intende concluso nel momento in cui l'Acquirente riceve dal Venditore la conferma del proprio ordine.

3.2 Gli ordini e le conferme d'ordine devono essere necessariamente redatti in forma scritta e sottoscritti dall'Acquirente e possono essere trasmessi anche a mezzo fax o posta elettronica.

3.3 Qualora l'ordine sia preceduto da un'offerta del Venditore, l'Acquirente dovrà fare riferimento ad essa per l'emissione dell'ordine, fermo restando che, in ogni caso, i termini e le condizioni di fornitura specificati nell'offerta diventeranno vincolanti per il Venditore solo se e nei limiti in cui l'ordine venga successivamente confermato per iscritto dal medesimo.

3.4 Gli ordini e/o le modifiche di ordini effettuati verbalmente o telefonicamente devono essere confermati per iscritto dall'Acquirente che riceverà, a sua volta, la relativa conferma d'ordine da parte del Venditore. In caso contrario il Venditore non si assume alcuna responsabilità con riguardo a eventuali errori o possibili fraintendimenti.

3.5 I costi relativi ad eventuali modifiche o trasformazioni da eseguirsi sui Prodotti, laddove possibili, saranno a carico dell'Acquirente.

3.6 Laddove i contratti di compravendita prevedano più consegne nel tempo, il Venditore si riserva la facoltà di apportare ai Prodotti tutte le modifiche di natura estetica, dimensionale e tecnica che, nel rispetto delle relative caratteristiche funzionali e della normativa vigente, dovessero rendersi necessarie od opportune, senza che per ciò l'Acquirente possa avanzare pretese o reclami di alcun tipo.

#### ART. 4 - PREZZI E PAGAMENTI

4.1 Salvo diversa pattuizione, i prezzi sono indicati in Euro, comprensivi di imballaggio, con esclusione di IVA, imposte indirette, tasse, accise, così come qualsivoglia imposta a carico dell'Acquirente che sarà corrisposta da quest'ultimo; in caso di esenzione, l'Acquirente fornirà al Venditore appropriata documentazione.

4.2 Il Venditore potrà in qualsiasi momento modificare i prezzi dei Prodotti in conseguenza dell'aumento di costi delle materie prime e della manodopera; tuttavia, i Prodotti non saranno consegnati ovvero offerti a prezzi aumentati senza previa comunicazione.

4.3 Salvo diversa pattuizione, i pagamenti saranno effettuati presso la sede del Venditore, nel rispetto dei termini e delle condizioni concordate; i termini di pagamento decorrono dalla data della fattura.

4.5 In caso di resi parziali concordati, la fornitura dovrà essere comunque pagata per intero. Ricevuto il pagamento da parte dell'Acquirente, il Venditore provvederà ad emettere nota di accredito sul reso ricevuto nel rispetto delle stesse condizioni e termini di pagamento concessi all'Acquirente nel contratto.

#### ART. 5 - MANCATO O RITARDATO PAGAMENTO

5.1 Per nessuna ragione i pagamenti potranno essere ritardati e/o trattenuti; eventuali reclami o contestazioni non daranno diritto al rifiuto del pagamento ovvero ad eventuali compensazioni.

5.2 Fatti salvi tutti i diritti riconosciuti al Venditore, in caso di ritardo o difetto di pagamento entro i termini convenuti, o di rifiuto di presa in consegna dei Prodotti acquistati e senza pregiudizio all'esercizio dei diritti afferenti alla proprietà:

- a) saranno applicati gli interessi di mora, ai sensi del decreto legislativo n. 231/2002, a decorrere dalla data in cui sia maturato il diritto al pagamento;
- b) il Venditore potrà sospendere la consegna dei Prodotti così come interrompere la garanzia fino alla sua ripresa, senza pregiudizio sulla relativa data di scadenza nonché imputare le somme fino a quel momento ricevute ai debiti scaduti;
- c) l'Acquirente decadrà dal beneficio del termine con diritto per il Venditore di pretendere il pagamento immediato del debito residuo.

#### ART. 6 - TERMINI DI CONSEGNA

6.1 Se non diversamente concordato per iscritto, qualsiasi termine di consegna indicato non sarà

vincolante per il Venditore. Salvo diverso accordo tra le parti, il termine di consegna è indicativo ed è quello precisato nella conferma d'ordine.

6.2 Qualsiasi responsabilità inerente le consegne derivante da forza maggiore o da altri eventi imprevedibili - elencati a titolo esemplificativo, ma non esaustivo, nel successivo ART. 12 - non imputabili al Venditore, liberano quest'ultimo dall'obbligo di rispettare il termine di consegna pattuito anche se vincolante.

6.3 Indipendentemente da quanto pattuito in ordine alla resa (porto franco o assegnato) o ai costi di trasporto e di assicurazione, la consegna ed il conseguente trasferimento dei rischi si considereranno intervenuti, in ogni caso ed a tutti gli effetti, con il caricamento della merce sul mezzo di trasporto alla partenza presso lo stabilimento del Venditore.

6.4 Qualora l'acquirente non provveda al ritiro dei Prodotti o ad accettarne la consegna, il Venditore avrà la facoltà, trascorsi 15 giorni dalla diffida ed impregiudicati i rimedi previsti dalla legge, di risolvere il contratto e di rivendere al meglio i Prodotti non ritirati, comunicando all'Acquirente i termini e le condizioni di vendita, trattenendo in via definitiva e a titolo di penale, l'acconto e le eventuali rate di prezzo già versate dal Cliente. La differenza tra il prezzo contrattuale (maggiorato delle spese di custodia e conservazione) e quello ricavato dalla rivendita a terzi costituirà debito del Cliente, su cui maturano gli interessi di mora nella misura indicata all'ART. 5.2, lett. a). È fatto comunque salvo il diritto del Venditore al risarcimento del maggior danno eventualmente sofferto.

#### ART. 7 - RISERVA DI PROPRIETÀ E TRASFERIMENTO DEI RISCHI

7.1 Il Venditore conserva la proprietà dei Prodotti fino al completo pagamento degli stessi ivi compresi i costi accessori.

7.2 Intervenuta la consegna, l'Acquirente sarà responsabile per tutti i danni che i Prodotti potranno subire o causare.

7.3 Fino a che non sia intervenuto il completo pagamento, i Prodotti non potranno essere rivenduti senza il previo consenso scritto del Venditore.

#### ART. 8 - TERMINI DI GARANZIA

8.1 I Prodotti sono fabbricati nel rispetto della normativa applicabile ed il Venditore offre garanzia per un periodo di 24 (ventiquattro) mesi dalla data di consegna.

8.2 Qualsivoglia vizio deve essere denunciato con le modalità previste dal successivo ART. 14 entro 8 (otto) giorni dalla data di consegna. In caso di vizi occulti il termine di 8 (otto) giorni inizia a decorrere dal momento della loro scoperta.

8.3 Qualora l'Acquirente sia un "Consumatore", così come definito nell'ART. 3 del Codice del Consumo (decreto legislativo n. 206/2005), la denuncia per l'eventuale difetto di conformità del Prodotto deve essere effettuata entro 2 (due) mesi dalla scoperta.

8.4 Il Venditore non è responsabile per qualsivoglia vizio dei Prodotti derivante da disegni, design o specifiche tecniche fornite dall'Acquirente, così come per i vizi derivanti da usura, inappropriato od inadatto magazzinaggio o modalità d'uso, negligenza o imperizia, manomissione o alterazione dei Prodotti posti in essere dall'Acquirente o da terzi.

8.5 Il Venditore non è responsabile per danni o perdite di qualsiasi genere o natura occorsi alla totalità o parte dei Prodotti durante il trasporto, indipendentemente dal fatto che il trasporto si effettuato da un vettore incaricato da terzi, dall'Acquirente o dallo stesso Venditore, che in tale ultimo caso non assume nessuna garanzia in tal senso liberandosi dall'obbligo della consegna con la semplice rimessa al vettore.

8.6 Nel caso in cui un reclamo per difetti o vizi si riveli ben fondato, la garanzia sarà limitata alla sostituzione o alla riparazione dei Prodotti viziati o dei componenti difettosi con espressa esclusione di qualsivoglia risoluzione contrattuale, riduzione del prezzo, sospensione del pagamento o interruzione della garanzia. La sostituzione dei

Prodotti difettosi sarà a discrezione del Venditore previa verifica presso i propri laboratori.

#### ART. 9 - LIMITAZIONE DELLA RESPONSABILITA'

9.1 Il Venditore non è responsabile per i danni diretti, indiretti e consequenziali senza limitazione alcuna, sofferti da cose o persone durante l'uso e/o la manutenzione dei Prodotti venduti. In tali casi l'Acquirente dovrà mantenere il Venditore esente ed immune da qualsivoglia eventuale domanda, azione, procedura e/o reclamo azionato da terzi danneggiati nei confronti del medesimo.

9.2 L'eventuale responsabilità del Venditore sarà, in ogni caso, limitata al costo dei prodotti difettosi che hanno dato origine a tale responsabilità così come quantificati dal prezzo netto fatturato all'Acquirente.

#### ART. 10 - DIRITTI DI PROPRIETA' INDUSTRIALE ED INTELLETTUALE

10.1 I marchi, brevetti, disegni, progetti, prototipi, segreti industriali, know-how così come qualsivoglia relativo diritto di proprietà industriale ed intellettuale sono di titolarità esclusiva di LEUCOS e rimangono di proprietà della stessa anche successivamente alla vendita dei Prodotti.

10.2 L'Acquirente per poter esporre i marchi e/o fregi del Venditore nell'ambito della sua attività deve ricevere per iscritto dal medesimo preventiva autorizzazione.

#### ART. 11 - RISOLUZIONE DEL CONTRATTO

11.1 Nel caso in cui l'Acquirente non effettui il pagamento entro il termine prescritto o si renda inadempiente in modo continuativo o grave senza porvi rimedio entro 30 (trenta) giorni lavorativi decorrenti dalla diffida inviata da LEUCOS, il Venditore potrà immediatamente risolvere il contratto, salvo ed impregiudicato ogni ulteriore diritto.

11.2 In ogni caso, LEUCOS potrà immediatamente risolvere il contratto, nel caso di dichiarazione di fallimento dell'Acquirente, liquidazione, sospensione dei pagamenti o pignoramento, insolvenza ovvero ogni altra situazione che possa incidere sull'adempimento dell'Acquirente.

#### ART. 12 - FORZA MAGGIORE

12.1 Se l'esecuzione del contratto o di ogni altra obbligazione (diversa dal pagamento) è ostacolata, limitata ovvero impedita da eventi di forza maggiore che persistano per più di 3 (tre) mesi, ciascuna parte potrà risolvere il contratto, senza responsabilità alcuna.

12.2 Per "Evento di forza maggiore" si intende ogni evento al di là del ragionevole controllo della parte interessata, inclusi, senza limitazione alcuna, sciopero, serrata, boicottaggio, guerra, insurrezione, guerra civile, atto vandalico, adeguamento a leggi o disposizioni governative, norme, regolamenti o direttive, incidente, guasto agli impianti o macchinari, incendio, inondazione, difficoltà, ovvero aumento dei costi della manodopera o dei trasporto nonché qualsivoglia altra circostanza in grado di compromettere la fornitura dei Prodotti.

12.3 La parte interessata informerà direttamente l'altra parte del verificarsi dell'evento di forza maggiore di cui abbia avuto conoscenza e che ritenga possa compromettere l'esecuzione del contratto.

#### ART. 13 - TRATTAMENTO DEI DATI PERSONALI

13.1 dati personali dell'Acquirente saranno trattati secondo quanto disposto dalla legge italiana in materia di trattamento dei dati personali (decreto legislativo n. 196/2003). Il Venditore informa l'Acquirente che il Venditore è il titolare del trattamento e che i dati personali dell'Acquirente vengono raccolti e trattati esclusivamente per l'esecuzione del contratto.

13.2 Per qualsivoglia ulteriore informazione si fa riferimento all'informativa sulla privacy presente nel sito [www.leucos.com](http://www.leucos.com).

#### ART. 14 - COMUNICAZIONI

Fatta eccezione per le informazioni di carattere operativo, tutte le comunicazioni saranno trasmesse per

iscritto, via fax, lettera raccomandata a/r o P.E.C. o corriere espresso a: LEUCOS, via del Commercio 22, 36060 Romano d'Ezzelino (VI) ITALY; PEC: [clannsr1@legalmail.it](mailto:clannsr1@legalmail.it)

#### ART. 15 - LEGGE APPLICABILE E FORO COMPETENTE

15.1 Le presenti Condizioni Generali di Vendita LEUCOS, così come ogni relativo contratto di compravendita ed ogni questione che trae origine dagli stessi ovvero connessa, sarà disciplinata, interpretata, eseguita e retta dalla legge ed i regolamenti italiani in vigore, con espressa esclusione della Convenzione di Vienna del 1980 relativa ai contratti di vendita internazionale di beni.

15.2 Qualsiasi controversia insorta tra le parti a seguito dell'interpretazione, validità o esecuzione delle presenti Condizioni Generali di Vendita LEUCOS e dei relativi contratti stipulati sarà devoluta alla competenza esclusiva del Tribunale di Venezia, ogni altro Foro escluso.

15.3 Resta inteso tra le parti che soltanto il Venditore, a propria discrezione, avrà la facoltà di rinunciare alla competenza del Foro esclusivo, di cui al punto 15.2 che precede, per agire in giudizio nei confronti dell'Acquirente, al suo domicilio e presso il Tribunale ivi competente.

#### ART. 16 - DISPOSIZIONI FINALI

16.1 Diritti e obblighi derivanti dalle presenti Condizioni Generali di Vendita LEUCOS e i relativi contratti di compravendita non potranno essere ceduti senza il previo consenso scritto del Venditore.

16.2 L'invalidità in tutto o in parte di singole disposizioni delle presenti Condizioni Generali di Vendita LEUCOS non inficia la validità delle restanti previsioni.

16.3 I diritti o rimedi di LEUCOS previsti dalle presenti Condizioni Generali di Vendita LEUCOS non pregiudicano qualsivoglia altro diritto o rimedio disposto dalla legge applicabile.

16.4 Il difetto o il ritardo da parte di LEUCOS nell'esercizio dei propri diritti non costituisce rinuncia o perdita di tale diritto.

16.5 La rubricazione degli articoli delle presenti Condizioni Generali LEUCOS in alcun modo potrà essere interpretata quale limitazione ovvero estensione della portata del contenuto della particolare sezione alla quale si riferisce.

16.6 Le presenti Condizioni Generali di Vendita LEUCOS sono redatte in duplice lingua italiana e inglese. In caso sorgessero dubbi interpretativi prevarrà la versione in italiano.

16.7 Le presenti Condizioni Generali di Vendita LEUCOS entrano in vigore dal 29 marzo 2019 e sostituiscono le precedenti.

16.8 In caso di giustificato motivo, i resi di merce dovranno comunque essere autorizzati per iscritto dall'ufficio commerciale del Venditore, che comunicherà le istruzioni cui attenersi. Condizioni Generali di Vendita LEUCOS e i relativi contratti di compravendita non potranno essere ceduti senza il previo consenso scritto del Venditore.

16.9 L'invalidità in tutto o in parte di singole disposizioni delle presenti Condizioni Generali di Vendita LEUCOS non inficia la validità delle restanti previsioni.

Ai sensi e per gli effetti di cui agli articoli 1341 e 1342 del Codice Civile, l'Acquirente dichiara di approvare espressamente le seguenti clausole delle Condizioni Generali di Vendita LEUCOS: 1.3 (aspetti generali); 3 (conclusione del contratto); 6 (termini di consegna); 8.5 - 8.6 (termini di garanzia); 9 (limitazione della responsabilità); 15 (legge applicabile e foro competente); 16 (disposizioni finali).



The list prices are inclusive of the charges introduced by the law by decree dated 25th July 2005, n. 151 (Regulations 2002/95/CE, 2002/96/CE e 2003/108/CE relative to the use reduction of dangerous substances in the electrical and electronic equipment (AEE) as well as to the waste disposal).  
WEEE: Waste of electrical and electronic equipment.

I prezzi indicati nel presente listino sono inclusi da oneri introdotti dal decreto legislativo 25 luglio 2005, n. 151 (attuazione delle direttive 2002/95/CE, 2002/96/CE e 2003/108/CE, relative alla riduzione dell'uso di sostanze pericolose nelle apparecchiature elettriche ed elettroniche (AEE), nonché allo smaltimento dei rifiuti). RAEE: Rifiuti di apparecchi elettrici ed elettronici = WEEE: Waste of electrical and electronic equipment.

LEUCOS SRL

VIA DEL COMMERCIO, 22 ADDRESS

36060 ROMANO D'EZZELINO CITY

(VICENZA) ITALY STATE

+39 041 5741111 PHONE

INFO.IT@LEUCOS.COM EMAIL

LEUCOS USA INC.

11 MAYFIELD AVENUE ADDRESS

EDISON NEW JERSEY, 08837 CITY

UNITED STATES OF AMERICA STATE

001 732 225-0010 PHONE

INFO.US@LEUCOS.COM EMAIL

LEUCOS.COM ONLINE

LEUCOS

PRICE LIST

2023

EMEA

LEUCOS

## JJ GREAT - Floor Indoor

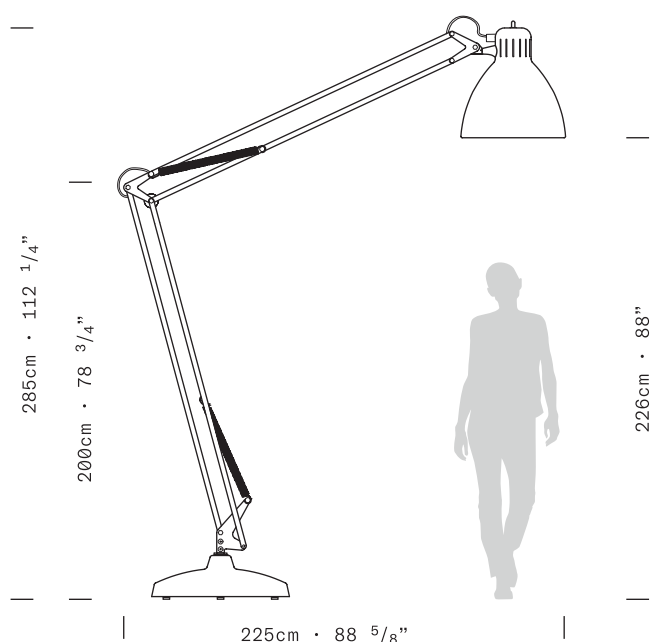

**MATERIALS** Aluminum, steel base

**DIMENSIONS** Diffuser: ø56cm h59cm [ø22" h23 1/4"]  
Base: ø74cm [ø29 1/8"]  
Structure: maximum height 420cm [165 3/8"]  
maximum outreach 385cm [151 3/8"]  
Cable length: 350cm [137 3/4"]

**LIGHT SOURCE** LED 1 x 45W 6691lm 3000K or 6433lm  
2700K CRI≥90 (user replaceable) [E]  
MacAdam 3-step

\*All LED lamps are available in either  
2700K or 3000K

**MARKING**   DRY LOCATION

## PRICE LIST

CONTROL	FINISH	CODE	UNIT PRICE
Dimmer (push-dim)	matte white	0011140	€ 6.901,00
	matte black	0011141	€ 6.901,00
	matte amarant red	0011142	€ 6.901,00
	matte mica blue	0011143	€ 6.901,00
	matte sablé grey	0011144	€ 7.017,00
	rust brown	0011145	€ 7.017,00
	custom RAL color	N/A	€ 7.732,00
Wireless CASAMBI® Smart Lighting Control	matte white	0011150	€ 7.017,00
	matte black	0011151	€ 7.017,00
	matte amarant red	0011152	€ 7.017,00
	matte mica blue	0011153	€ 7.017,00
	matte sablé grey	0011154	€ 7.132,00
	rust brown	0011155	€ 7.132,00
	custom RAL color	N/A	€ 7.847,00
LED MODULE OPTIONS	2700K LED	8000334	included*
	3000K LED	8000328	included*

**NOTE** All prices are VAT excluded

## JJ BIG - Floor Indoor

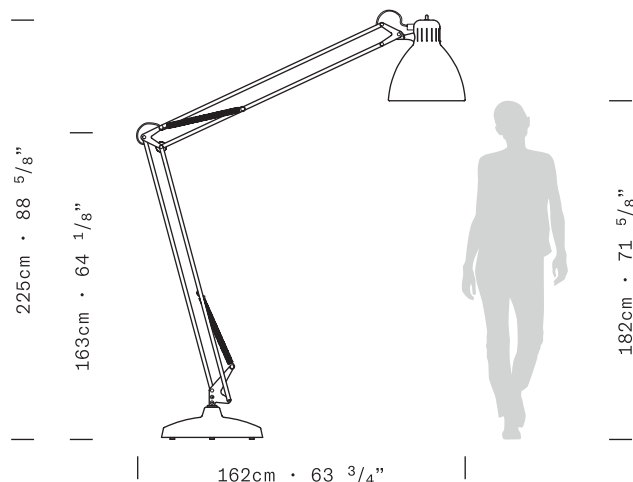

**MATERIALS** Aluminum, steel base

**DIMENSIONS** Diffuser: ø41cm h43cm [ø16 1/8" h16 7/8"]  
Base: ø54cm [ø21 1/4"]  
Structure: maximum height 315cm [124"]  
maximum outreach 295cm [115 3/4"]  
Cable length: 350cm [137 3/4"]

**LIGHT SOURCE** LED 1 x 45W 6691lm 3000K or 6433lm  
2700K CRI≥90 (user replaceable) [E]  
MacAdam 3-step

\*All LED lamps are available in either  
2700K or 3000K

**MARKING**   DRY LOCATION

## PRICE LIST

CONTROL	FINISH	CODE	UNIT PRICE
Dimmer (push-dim)	matte white	0011100	€ 3.148,00
	matte black	0011101	€ 3.148,00
	matte amarant red	0011102	€ 3.148,00
	matte mica blue	0011103	€ 3.148,00
	matte sablé grey	0011104	€ 3.269,00
	rust brown	0011105	€ 3.269,00
	custom RAL color	N/A	€ 3.972,00
Wireless CASAMBI® Smart Lighting Control	matte white	0011110	€ 3.269,00
	matte black	0011111	€ 3.269,00
	matte amarant red	0011112	€ 3.269,00
	matte mica blue	0011113	€ 3.269,00
	matte sablé grey	0011114	€ 3.400,00
	rust brown	0011115	€ 3.400,00
	custom RAL color	N/A	€ 4.082,00
LED MODULE OPTIONS	2700K LED	8000310	included*
	3000K LED	8000311	included*

**NOTE** All prices are VAT excluded

## JJ GREAT - Floor Outdoor

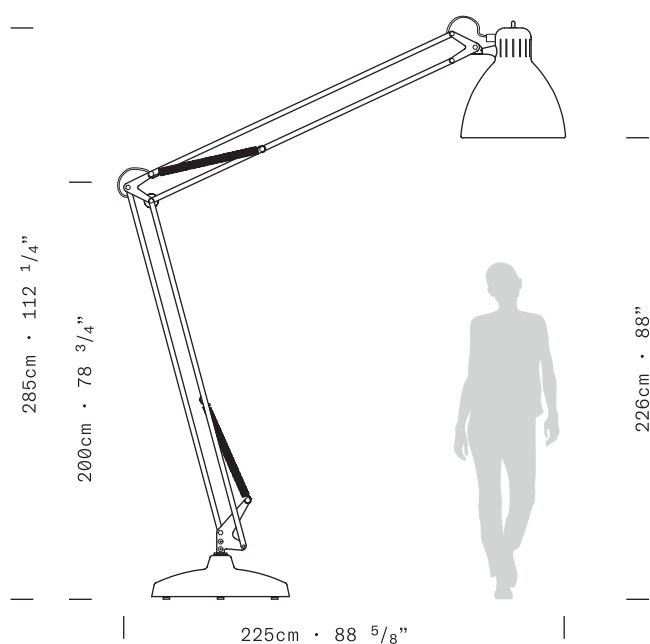

**MATERIALS** Aluminum, steel base

**DIMENSIONS** Diffuser: ø56cm h59cm [ø22" h23 1/4"]  
Base: ø74cm [ø29 1/8"]  
Structure: maximum height 420cm [165 3/8"]  
maximum outreach 385cm [151 3/8"]  
Cable length: 350cm [137 3/4"]

**LIGHT SOURCE** LED 1 x 45W 6691lm 3000K or 6433lm  
2700K CRI≥90 (user replaceable) [E]  
MacAdam 3-step

\*All LED lamps are available in either  
2700K or 3000K

**MARKING**    DAMP LOCATION  WET LOCATION

## PRICE LIST

CONTROL	FINISH	CODE	UNIT PRICE
Wireless CASAMBI® Smart Lighting Control	matte white	0011160	€ 7.537,00
	matte black	0011161	€ 7.537,00
	matte amarant red	0011162	€ 7.537,00
	matte mica blue	0011163	€ 7.537,00
	matte sablé grey	0011164	€ 7.653,00
	rust brown	0011165	€ 7.653,00
	custom RAL color	N/A	€ 8.388,00
LED MODULE OPTIONS	2700K LED	8000329	included*
	3000K LED	8000330	included*

**NOTE** All prices are VAT excluded

## JJ BIG - Floor Outdoor

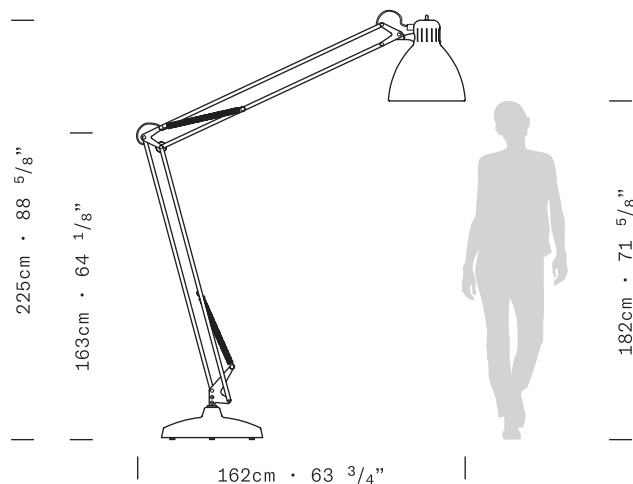

**MATERIALS** Aluminum, steel base

**DIMENSIONS** Diffuser: ø41cm h43cm [ø16 1/8" h16 7/8"]  
Base: ø54cm [ø21 1/4"]  
Structure: maximum height 315cm [124"]  
maximum outreach 295cm [115 3/4"]  
Cable length: 350cm [137 3/4"]

**LIGHT SOURCE** LED 1 x 45W 6691lm 3000K or 6433lm  
2700K CRI≥90 (user replaceable) [E]  
MacAdam 3-step

\*All LED lamps are available in either  
2700K or 3000K

**MARKING**    DAMP LOCATION  WET LOCATION

## PRICE LIST

CONTROL	FINISH	CODE	UNIT PRICE
Wireless CASAMBI® Smart Lighting Control	matte white	0011120	€ 3.297,00
	matte black	0011121	€ 3.297,00
	matte amarant red	0011122	€ 3.297,00
	matte mica blue	0011123	€ 3.297,00
	matte sablé grey	0011124	€ 3.407,00
	rust brown	0011125	€ 3.407,00
	custom RAL color	N/A	€ 4.090,00
LED MODULE OPTIONS	2700K LED	8000312	included*
	3000K LED	8000313	included*

**NOTE** All prices are VAT excluded

## JJ GREAT - Pendant

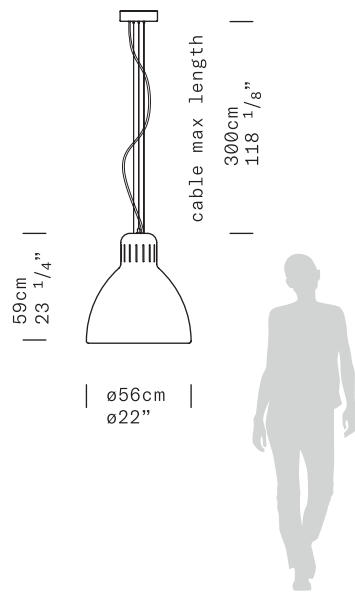

<b>MATERIALS</b>	Aluminum
<b>DIMENSIONS</b>	Diffuser: $\varnothing 56\text{cm}$ h59cm [ $\varnothing 22''$ h23 $\frac{1}{4}''$ ] Canopy: $\varnothing 20\text{cm}$ h5.6cm [ $\varnothing 7 \frac{7}{8}''$ h2 $\frac{1}{4}''$ ] Cable length: 300cm [ $118 \frac{1}{8}''$ ]
<b>LIGHT SOURCE</b>	LED 1 x 45W 66911m 3000K or 64331m 2700K CRI $\geq$ 90 (user replaceable) [E] MacAdam 3-step  *All LED lamps are available in either 2700K or 3000K

<b>MARKING</b>	
----------------	--

### PRICE LIST

CONTROL	FINISH	CODE	UNIT PRICE
Push-dim; 0/1-10V; DALI	matte white	0011170	€ 1.144,00
	matte black	0011171	€ 1.144,00
	matte amarant red	0011281	€ 1.144,00
	matte mica blue	0011282	€ 1.144,00
	matte sablé grey	0011283	€ 1.201,00
	rust brown	0011284	€ 1.201,00
LED MODULE OPTIONS	2700K LED	8000334	included*
	3000K LED	8000328	included*

**NOTE** All prices are VAT excluded

## JJ BIG - Pendant

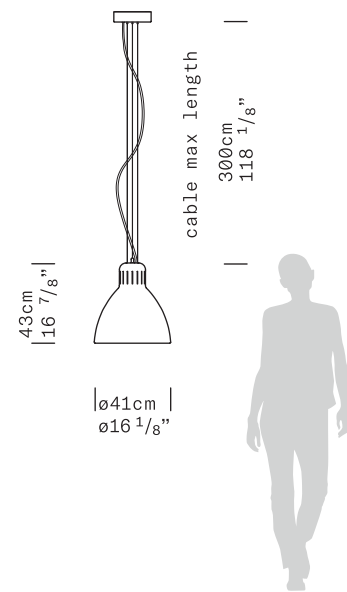

<b>MATERIALS</b>	Aluminum
<b>DIMENSIONS</b>	Diffuser: $\varnothing 41\text{cm}$ h43cm [ $\varnothing 16 \frac{1}{8}''$ h16 $\frac{7}{8}''$ ] Canopy: $\varnothing 20\text{cm}$ h5.6cm [ $\varnothing 7 \frac{7}{8}''$ h2 $\frac{1}{4}''$ ] Cable length: 300cm [ $118 \frac{1}{8}''$ ]
<b>LIGHT SOURCE</b>	LED 1 x 45W 66911m 3000K or 64331m 2700K CRI $\geq$ 90 (user replaceable) [E] MacAdam 3-step  *All LED lamps are available in either 2700K or 3000K

<b>MARKING</b>	
----------------	--

### PRICE LIST

CONTROL	FINISH	CODE	UNIT PRICE
Push-dim; 0/1-10V; DALI	matte white	0011130	€ 761,00
	matte black	0011131	€ 761,00
	matte amarant red	0011285	€ 761,00
	matte mica blue	0011286	€ 761,00
	matte sablé grey	0011287	€ 816,00
	rust brown	0011288	€ 816,00
LED MODULE OPTIONS	2700K LED	8000310	included*
	3000K LED	8000311	included*

**NOTE** All prices are VAT excluded



# JJ BIG - Grip Indoor

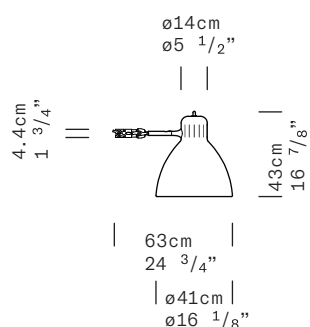

<b>MATERIALS</b>	Aluminum
<b>DIMENSIONS</b>	Diffuser: ø41cm h43cm [ø16 1/8" h16 7/8"] Cable lenght: 500cm [196 7/8"] + 150cm [59"] push dimmer
<b>LIGHT SOURCE</b>	LED 1 x 45W 66911m 3000K or 64331m 2700K CRI≥90 (user replaceable) [E] MacAdam 3-step  *All LED lamps are available in either 2700K or 3000K

**MARKING**   DRY LOCATION

## PRICE LIST

CONTROL	FINISH	CODE	UNIT PRICE
Dimmer (push-dim)	matte white	0011300	€ 960,00
	matte black	0011301	€ 960,00
	matte amarant red	0011302	€ 960,00
	matte mica blue	0011303	€ 960,00
	matte sablé grey	0011304	€ 1.014,00
	rust brown	0011305	€ 1.014,00
LED MODULE OPTIONS	2700K LED	8000310	included*
	3000K LED	8000311	included*

**NOTE** All prices are VAT excluded

The Autopole and Grip Mount accessories  
available (see sheet N.6)

# JJ BIG - Grip Outdoor

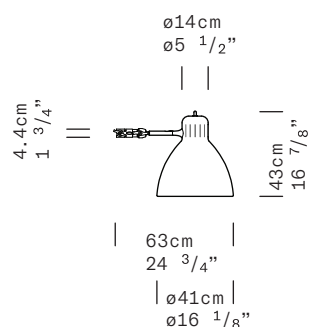

<b>MATERIALS</b>	Aluminum
<b>DIMENSIONS</b>	Diffuser: ø41cm h43cm [ø16 1/8" h16 7/8"] Cable lenght: 500cm [196 7/8"]
<b>LIGHT SOURCE</b>	LED 1 x 45W 66911m 3000K or 64331m 2700K CRI≥90 (user replaceable) [E] MacAdam 3-step  *All LED lamps are available in either 2700K or 3000K

**MARKING**    DAMP LOCATION  WET LOCATION

## PRICE LIST

CONTROL	FINISH	CODE	UNIT PRICE
Wireless CASAMBI® Smart Lighting Control	matte white	0011310	€ 1.180,00
	matte black	0011311	€ 1.180,00
	matte amarant red	0011312	€ 1.180,00
	matte mica blue	0011313	€ 1.180,00
	matte sablé grey	0011314	€ 1.235,00
	rust brown	0011315	€ 1.235,00
LED MODULE OPTIONS	2700K LED	8000312	included*
	3000K LED	8000313	included*

**NOTE** All prices are VAT excluded

# JJ BIG - Grip Indoor Accessories

## AUTOPOLE

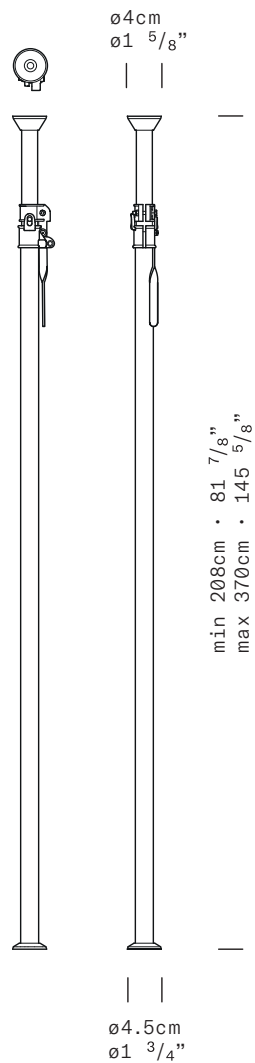

## GRIP MOUNT

L50 CM [19  $\frac{5}{8}''$ ]

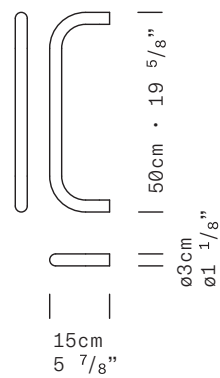

## GRIP MOUNT

L120 CM [47  $\frac{1}{4}''$ ]

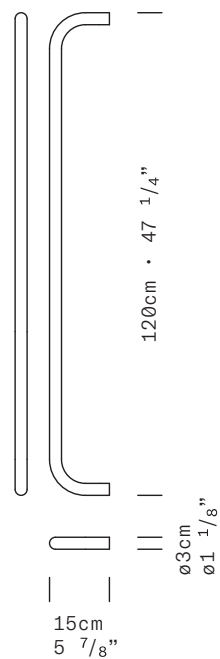

## PRICE LIST

ACCESSORIES	FINISH	CODE	UNIT PRICE
AUTOPOLE	anodized aluminum	8000320	€ 166,00
GRIP MOUNT 50 CM	polished anodized metal	8000321	€ 99,00
GRIP MOUNT 120 CM	polished anodized metal	8000322	€ 131,00

**NOTE** All prices are VAT excluded

## JJ MID - Floor

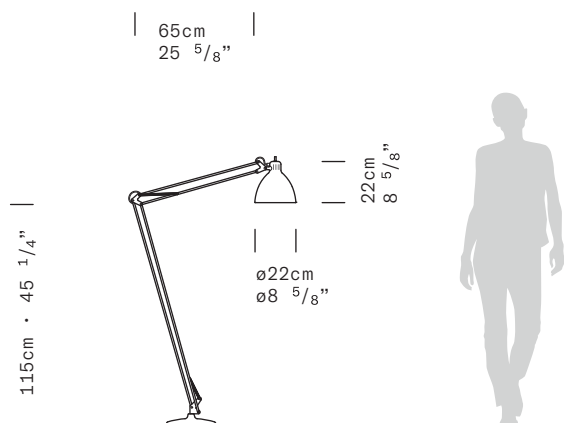

**MATERIALS** Steel, aluminum diffuser and base

**DIMENSIONS** Diffuser:  $\varnothing 22\text{cm}$  h22cm [ $\varnothing 8 \frac{5}{8}''$  h8  $\frac{5}{8}''$ ]  
Base:  $\varnothing 27.5\text{cm}$  [ $\varnothing 10 \frac{7}{8}''$ ]  
Structure: maximum height 185cm [ $72 \frac{7}{8}''$ ];  
maximum outreach 135cm [ $53 \frac{1}{8}''$ ]  
Cable length: 220cm [ $86 \frac{5}{8}''$ ]

**LIGHT SOURCE** LED 1 x 13W 1600lm 3000K or 1490lm  
2700K CRI $\geq 90$  (user replaceable) [F]  
E27 1 x 10W Retrofit LED [F]

\*All LED lamps are available in either  
2700K or 3000K

**MARKING**   DRY LOCATION

## PRICE LIST

CONTROL	FINISH	CODE	UNIT PRICE
LED: touch dimmer (on diffuser)	matte white	0011340	€ 682,00
	matte black	0011341	€ 682,00
	matte amarant red	0011342	€ 682,00
	matte mica blue	0011343	€ 682,00
	matte sablé grey	0011344	€ 716,00
	rust brown	0011345	€ 716,00
LED MODULE OPTIONS	2700K LED	8000325	included*
	3000K LED	8000327	included*
E27: on-off (on diffuser)	matte white	0011350	€ 616,00
	matte black	0011351	€ 616,00
	matte amarant red	0011352	€ 616,00
	matte mica blue	0011353	€ 616,00
	matte sablé grey	0011354	€ 652,00
	rust brown	0011355	€ 652,00

**NOTE** All prices are VAT excluded

## JJ MID - Wall

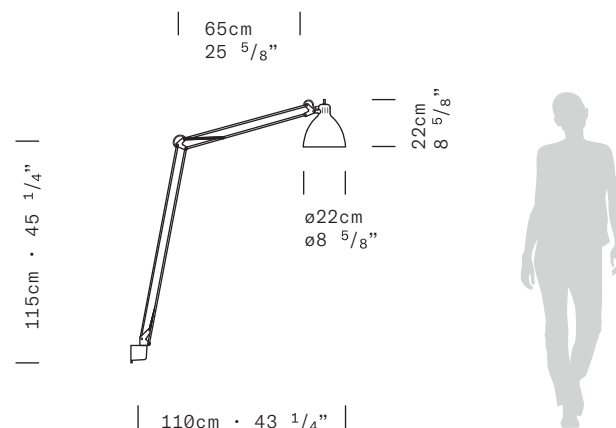

**MATERIALS** Steel, aluminum diffuser

**DIMENSIONS** Diffuser:  $\varnothing 22\text{cm}$  h22cm [ $\varnothing 8 \frac{5}{8}''$  h8  $\frac{5}{8}''$ ]  
Structure: maximum height 185cm [ $72 \frac{7}{8}''$ ]  
maximum outreach 195cm [ $76 \frac{3}{4}''$ ]  
Cable length: 220cm [ $86 \frac{5}{8}''$ ]

**LIGHT SOURCE** LED 1 x 13W 1600lm 3000K or 1490lm  
2700K CRI $\geq 90$  (user replaceable) [F]  
E27 1 x 10W Retrofit LED [F]

\*All LED lamps are available in either  
2700K or 3000K

**MARKING**   DRY LOCATION

## PRICE LIST

CONTROL	FINISH	CODE	UNIT PRICE
LED: touch dimmer (on diffuser)	matte white	0011320	€ 613,00
	matte black	0011321	€ 613,00
	matte amarant red	0011322	€ 613,00
	matte mica blue	0011323	€ 613,00
	matte sablé grey	0011324	€ 647,00
	rust brown	0011325	€ 647,00
LED MODULE OPTIONS	2700K LED	8000325	included*
	3000K LED	8000327	included*
E27: on-off (on diffuser)	matte white	0011330	€ 520,00
	matte black	0011331	€ 520,00
	matte amarant red	0011332	€ 520,00
	matte mica blue	0011333	€ 520,00
	matte sablé grey	0011334	€ 554,00
	rust brown	0011335	€ 554,00
WALL BRACKET B-LARGE FINISHES	matte white	8000092	included**
	matte black	8000094	included**

**NOTE** All prices are VAT excluded

\*\*JJ Mid Wall requires the B-large mounting wall bracket (matte white or matte black)

# JJ SMALL

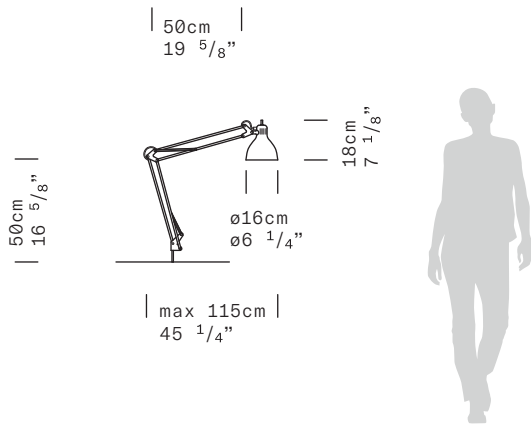

<b>MATERIALS</b>	Steel, aluminum diffuser
<b>DIMENSIONS</b>	Diffuser: $\phi 16\text{cm}$ h18cm [ $\phi 6 \frac{1}{4}''$ h7 $\frac{1}{8}''$ ] Structure: minimum height 50cm [ $16 \frac{5}{8}''$ ]; maximum outreach 115cm [ $45 \frac{1}{4}''$ ] Cable lenght: 200cm [ $78 \frac{3}{4}''$ ]
<b>LIGHT SOURCE</b>	LED 1 x 13W 1600lm 3000K CRI $\geq$ 90 (user replaceable) [F] E27 1 x 10W Retrofit LED [F]
<b>MARKING</b>	DRY LOCATION

**PRICE LIST**

CONTROL	FINISH	CODE	UNIT PRICE
LED: touch dimmer (on diffuser)	matte white	0011360	€ 329,00
	matte black	0011361	€ 329,00
	matte amarant red	0011362	€ 329,00
	matte mica blue	0011363	€ 329,00
	matte sablé grey	0011364	€ 352,00
	rust brown	0011365	€ 352,00
LED MODULE OPTIONS	3000K LED	8000326	included
E27: on-off (on diffuser)	matte white	0011370	€ 221,00
	matte black	0011371	€ 221,00
	matte amarant red	0011372	€ 221,00
	matte mica blue	0011373	€ 221,00
	matte sablé grey	0011374	€ 244,00
	rust brown	0011375	€ 244,00

**NOTE** All prices are VAT excluded  
JJ Small requires a separate mounting attachment (see on the right)

# JJ SMALL - Accessories

**TABLE CLAMP**  
A-AX

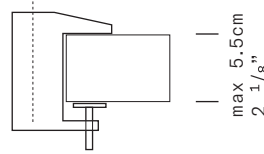

**TABLE CLAMP**  
A-LUNGO

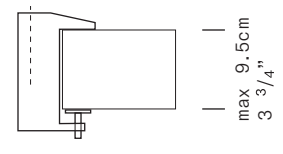

**FIXED BRACKET**  
C

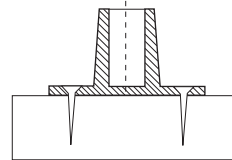

**WALL BRACKET**  
B-LARGE

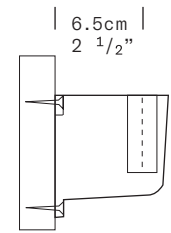

**ROUND BASE**

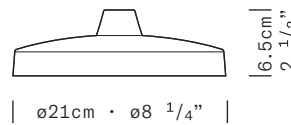
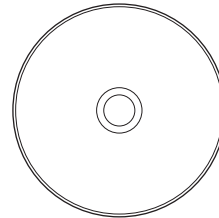

**PRICE LIST**

ACCESSORIES	FINISH	CODE	UNIT PRICE
TABLE CLAMP A-AX	matte white	8000301	€ 24,00
	matte black	8000303	€ 24,00
TABLE CLAMP A-LUNGO	matte white	8000088	€ 24,00
	matte black	8000090	€ 24,00
FIXED BRACKET C	matte white	8000095	€ 24,00
	matte black	8000097	€ 24,00
ROUND BASE	matte white	8000078	€ 87,00
	matte black	8000080	€ 87,00
	matte amarant red	8000335	€ 87,00
	matte mica blue	8000331	€ 87,00
	matte sablé grey	8000332	€ 87,00
	rust brown	8000333	€ 87,00
WALL BRACKET B-LARGE	matte white	8000092	€ 24,00
	matte black	8000094	€ 24,00

**NOTE** All prices are VAT excluded  
Choose an accessory to complete the lamp

## GENERAL TERMS AND CONDITIONS OF SALE

### ART. 1 - GENERAL ASPECTS

1.1 The terms and conditions set out hereunder (the "LEUCOS General Terms and Conditions of Sale") are an integral part of the offers and/or proposals made by Leucos (hereinafter "Seller") and of the contracts concluded between Seller and any purchaser (hereinafter "Purchaser") concerning the sale of lighting devices and components, available in the collections bearing the LEUCOS trademark and included in the related catalog, as created and modified from time to time (hereinafter the "Products").

1.2 The LEUCOS General Terms and Conditions of Sale shall apply to all transactions concluded between Seller and Purchaser, without the need for an express reference thereto or for a specific agreement to this effect upon the conclusion of each transaction. All other terms and conditions shall only apply where confirmed in writing by Seller.

1.3 Seller reserves the right to amend, add to or vary the LEUCOS General Terms and Conditions of Sale, appending such variations to the offers or any correspondence sent to Purchaser in writing.

### ART. 2 - PRODUCT AVAILABILITY

2.1 Purchaser is aware and accepts that the Products shall be solely those available when the contract is concluded and/or the order is confirmed by Seller.

2.2 Seller reserves the right not to fill an order if the Products can no longer be manufactured or supplied for any reason.

### ART. 3 - CONCLUSION OF THE CONTRACT

3.1 Contracts governing the supply of Products shall be considered concluded when Purchaser receives confirmation of its order from Seller.

3.2 Orders and order confirmations must be drafted in written form and signed by Purchaser and may also be sent by fax or e-mail.

3.3 If an order is preceded by an offer by Seller, Purchaser must refer thereto for the issue of the order, it being understood, in any event, that the terms and conditions of supply specified in the offer shall become binding for Seller only if, and to the extent that, the order is subsequently confirmed by Seller in writing.

3.4 Orders and/or modifications of orders made orally or over the telephone shall be confirmed in writing by Purchaser, which shall then receive the pertinent order confirmation from Seller. If this does not occur, Seller assumes no liability for any errors or possible misunderstandings.

3.5 Purchaser shall be liable for the costs of any modifications or transformations to be applied to the Products, where possible.

3.6 Where the purchase and sale contracts provide for multiple deliveries over time, Seller reserves the right to make all modifications of an aesthetic, size and technical nature to the Products that prove necessary or appropriate, in accordance with their functional characteristics and applicable legislation, without this entitling Purchaser to make any demands or claims or any kind.

### ART. 4 - PRICES AND PAYMENTS

4.1 Unless otherwise agreed, prices are stated in euro, inclusive of packaging, but exclusive of VAT, indirect taxes, excise taxes and any taxes for which Purchaser is liable, which shall be paid by the latter. In the event of exemption, Purchaser shall provide Seller with the appropriate documentation.

4.2 Seller may modify the prices of the Products at any time as a consequence of an increase in the costs of raw materials and labor. However, the Products shall not be delivered or offered at increased prices without prior notice.

4.3 Unless otherwise agreed, payments shall be made on Seller's premises, in accordance with the agreed terms and conditions. The terms of payment shall begin to run from the date of the invoice.

4.5 In the event of agreed partial returns, the goods shall nonetheless be paid for in full. After receiving the payment from Purchaser, Seller shall issue a credit note for the return received in accordance with the same terms and conditions of payment applied to Purchaser in the contract.

### ART. 5 - NON-PAYMENT OR DELAYED PAYMENT

5.1 Payments may not be delayed and/or withheld for any reason. Any complaints or claims shall not give rise to the right to refuse payment or to offsetting.

5.2 Notwithstanding all rights granted to Seller, in the event of delayed payment or non-payment according to the agreed terms, or of refusal to accept delivery of the Products purchased, and without prejudice to rights relating to ownership:

- late payment interest shall apply, in accordance with Legislative Decree 231/2002, with effect from the date on which the payment comes due;
- Seller may suspend delivery of the Products, suspend the warranty until resumption of payment, without prejudice to the applicable due date, and allocate the sums previously received to the accounts past due;
- the acceleration clause having come into effect, Seller shall be entitled to demand immediate payment of the residual amount due.

### ART. 6 - DELIVERY TERMS

6.1 Unless otherwise agreed in writing, no delivery term indicated shall be binding for Seller. Unless otherwise agreed between the parties, delivery terms shall be indicative, as stated in the order confirmation.

6.2 Any liability relating to deliveries deriving from force majeure or other unforeseeable events - including, without limitation, those set out in Art. 12 hereunder - not attributable to Seller shall release Seller from its obligation to

comply with the agreed delivery term, even if binding.

6.3 Regardless of the agreed delivery terms (carriage paid to designated port or carriage forward) and of shipping and insurance costs, delivery shall be considered to have been made, and risks transferred accordingly, in all cases and for all intents and purposes, when the goods are loaded onto the vehicle at the moment of departure from Seller's facility.

6.4 If Purchaser does not collect the Products or accept delivery thereof, Seller shall be entitled, once 15 days have elapsed from notice, and without prejudice to the legal remedies, to terminate the contract and resell the Products not collected, informing Purchaser of the terms and conditions of sale, while definitively retaining the advance and any installments of the price already paid by the Client, by way of penalty. The difference between the contractual price (plus the costs of storage and safekeeping) and the proceeds of resale to third parties shall be due from Client, and late payment interest shall accrue on this amount at the rate specified in Art. 5.2 a). The foregoing is without prejudice to Seller's right to compensation for any additional damages suffered.

### ART. 7 - RETENTION OF TITLE AND TRANSFER OF RISKS

7.1 Seller shall retain title to the Products until they have been paid for in full, along with all additional costs.

7.2 Once delivery has been made, Purchaser shall be liable for all damages that the Products may suffer or cause.

7.3 Until payment in full, the Products may not be resold without Seller's prior written consent.

### ART. 8 - WARRANTY TERMS

8.1 The Products are manufactured in accordance with applicable legislation and Seller offers a warranty for a period of 24 (twenty-four) months from the date of delivery.

8.2 All defects shall be reported according to the conditions indicated in Art. 14 below within eight (8) days of the date of delivery. In the event of latent defects, the period of eight (8) days begins when the defects are discovered.

8.3 If Purchaser is a "Consumer" as defined in Art. 3 of the Consumer Code (Legislative Decree 206/2005), any defects of conformity of the Product must be reported within two (2) months of discovery.

8.4 Seller shall not be liable for any defect in the Products due to drawings, designs or technical specifications provided by Purchaser, or for defects due to wear and tear, inappropriate or improper storage or use, negligence or unskilled use, tampering with or alteration of the Products by Purchaser or by third parties.

8.5 Seller shall not be liable for damages or losses of any kind or nature suffered by part or all of the Products during shipment, regardless of whether shipment is provided by a carrier engaged by third parties, by Purchaser or by Seller, which in this latter case renders no warranty in respect thereof, and shall be released from its delivery obligation by simply delivering the goods to the carrier.

8.6 If a complaint of flaws or defects proves to be justified, the warranty shall be limited to replacement or repair of the defective Products or components, expressly excluding any termination of the contract, reduction of the price, suspension of payment or suspension of the warranty. Replacement of the defective Products shall be at Seller's discretion, following inspection in its laboratories.

### ART. 9 - LIMITATION OF LIABILITY

9.1 Seller shall not be liable for direct, indirect and consequential damages, without any limitation whatsoever, suffered by property or persons during the use and/or maintenance of the Products sold. In such cases, Purchaser shall hold Seller harmless and immune from any claims, actions, procedures and/or complaints by harmed third parties against Seller.

9.2 In any event, Seller's liability shall be limited to the cost of the defective products that gave rise to this liability, as quantified by the net price invoiced to Purchaser.

### ART. 10 - INDUSTRIAL AND INTELLECTUAL PROPERTY RIGHTS

10.1 Trademarks, patents, designs, plans, prototypes, industrial secrets, know-how and all related industrial and intellectual property rights shall be the sole property of LEUCOS and shall remain its property ever after the sale of the Products.

10.2 Purchaser must obtain Seller's prior written permission in order to use Seller's trademarks and/or signs in its activities.

### ART. 11 - TERMINATION

11.1 If Purchaser fails to make payment within the prescribed term or commits an ongoing or serious breach, without remedying it within 30 (thirty) business days from the date of notice to perform sent by LEUCOS, Seller may terminate the contract immediately, without prejudice to any further rights.

11.2 In any event, LEUCOS may terminate the contract immediately in the event of a bankruptcy declaration concerning Purchaser, liquidation, suspension of payments, attachment, insolvency or any other situation that may affect performance by Purchaser.

### ART. 12 - FORCE MAJEURE

12.1 If performance of the contract or of any other obligation (other than payment) is obstructed, limited or prevented by events of force majeure that persist for more than three (3) months, each party may terminate the contract, without any liability.

## CONDIZIONI GENERALI DI VENDITA

12.2 "Event of force majeure" is defined as any event that is beyond the reasonable control of the interested party, including, without limitation, strikes, lock-ins, boycotts, wars, insurrections, civil wars, acts of vandalism, compliance with laws or government orders, statutes, provisions or directives, accidents, breakdowns of plants or machinery, fires, floods, difficulties, increases in labor or shipping costs or any other circumstances capable of jeopardizing the supply of the Products.

12.3 The interested party shall inform the other party directly of the occurrence of the event of force majeure of which it has become aware and that it believes may jeopardize the performance of the contract.

### ART. 13 - PROCESSING OF PERSONAL DATA

13.1 Purchaser's personal data shall be processed in accordance with Italian legislation governing the processing of personal data (Legislative Decree 196/2003). Seller informs Purchaser that Seller is the data controller and that Purchaser's data shall be collected and processed solely for the performance of the contract.

13.2 Refer to the privacy policy statement on the website [www.leucos.com](http://www.leucos.com) for any further information.

### ART. 14 - COMMUNICATIONS

With the exception of information of an operational nature, all communications shall be sent in writing, by fax, registered mail with return receipt, certified e-mail (PEC) or express courier to:

LEUCOS, via del Commercio 22, 36060 Romano d'Ezzelino (VI) ITALY  
- PEC: [clannsr1@legalmail.it](mailto:clannsr1@legalmail.it)

### ART. 15 - APPLICABLE LAW AND COURT OF JURISDICTION

15.1 These LEUCOS General Terms and Conditions of Sale, all related purchase and sale contracts and all matters that derive herefrom or are related hereto, shall be governed, construed and implemented in accordance with the laws and regulations in effect in Italy, with the express exclusion of the the Vienna Convention on the International Sale of Goods 1980.

15.2 Any disputes that arise between the parties in connection with the interpretation, validity and performance of these LEUCOS General Terms and Conditions of Sale and the related contracts entered into shall come before the sole jurisdiction of the Court of Venice, to the exclusion of all other courts.

15.3 It is understood that only Seller, at its discretion, shall be entitled to waive the jurisdiction of the sole court of jurisdiction, as defined in Art. 15.2 above, in order to take legal action against Purchaser, in its domicile and before the Court with jurisdiction there.

### ART. 16 - FINAL PROVISIONS

16.1 The rights and obligations deriving from these LEUCOS General Terms and Conditions of Sale and related purchase and sale contracts may not be assigned without Seller's prior written consent.

16.2 The invalidity of part or all of the provisions of these LEUCOS General Terms and Conditions of Sale shall not undermine the validity of the remaining provisions.

16.3 The rights and remedies of LEUCOS provided for in these LEUCOS General Terms and Conditions of Sale shall not jeopardize any other right or remedy available according to applicable law.

16.4 Any failure to exercise, or delayed exercise, by LEUCOS of its rights shall not constitute waiver or forfeiture of such rights.

16.5 Under no circumstances may the headings of the articles of these LEUCOS General Terms and Conditions be construed as limiting or extending the scope of the content of the particular sections to which they refer.

16.6 These LEUCOS General Terms and Conditions of Sale have been drafted in both Italian and English language versions. In the event of interpretative doubts, the version in Italian shall prevail.

16.7 These LEUCOS General Terms and Conditions of Sale shall enter into effect on March 29, 2019 and shall supersede previous versions.

16.8 Where justified, returns of goods must nonetheless be authorized in writing by Seller's sales office, which shall issue the instructions to be followed. The LEUCOS General Terms and Conditions of Sale and related purchase and sale contracts may not be assigned without Seller's prior written consent.

16.9 The invalidity of part or all of the provisions of these LEUCOS General Terms and Conditions of Sale shall not undermine the validity of the remaining provisions.

Purchase to Articles 1341 and 1342 of the Italian Civil Code, Purchaser declares that it expressly approves the following clauses of the LEUCOS General Terms and Conditions of Sale: 1.3 (general aspects); 3 (conclusion of the contract); 6 (delivery terms); 8.5 - 8.6 (warranty terms); 9 (limitation of liability); 15 (applicable law and court of jurisdiction); and 16 (final provisions).

### ART. 1 - ASPETTI GENERALI

1.1 I termini e le condizioni qui di seguito indicati (le "Condizioni Generali di Vendita LEUCOS") formano parte integrante delle offerte e/o proposte formulate da Leucos (di seguito "Venditore") e dei contratti conclusi tra il Venditore e qualsivoglia Acquirente (di seguito "Acquirente") riguardanti la vendita di apparecchi di illuminazione e componenti, disponibili nelle collezioni contrassegnate dal marchio LEUCOS e presenti nel relativo catalogo, di volta in volta creati e modificati (di seguito i "Prodotti").

1.2 Le Condizioni Generali di Vendita LEUCOS si applicano a tutte le transazioni concluse tra il Venditore e l'Acquirente senza necessità che vi sia un espresso richiamo alle stesse o uno specifico accordo in tal senso alla conclusione di ogni singola transazione. Qualsiasi condizione o termine differente trova applicazione soltanto se confermato per iscritto da parte del Venditore.

1.3 Il Venditore si riserva il diritto di modificare, integrare o variare le Condizioni Generali di Vendita LEUCOS, allegando tali variazioni alle offerte ovvero a qualsivoglia corrispondenza inviata per iscritto all'Acquirente.

### ART. 2 - DISPONIBILITA' PRODOTTI

2.1 L'Acquirente è consapevole ed accetta che i Prodotti siano esclusivamente quelli disponibili al momento della conclusione del contratto e/o della conferma dell'ordine da parte del Venditore.

2.2 Il Venditore si riserva il diritto di non evadere l'ordine nel caso in cui i Prodotti non possano più, per qualunque motivo, essere fabbricati o forniti.

### ART. 3 - CONCLUSIONE DEL CONTRATTO

3.1 Il contratto avente ad oggetto la fornitura dei Prodotti si intende concluso nel momento in cui l'Acquirente riceve dal Venditore la conferma del proprio ordine.

3.2 Gli ordini e le conferme d'ordine devono essere necessariamente redatti in forma scritta e sottoscritti dall'Acquirente e possono essere trasmessi anche a mezzo fax o posta elettronica.

3.3 Qualora l'ordine sia preceduto da un'offerta del Venditore, l'Acquirente dovrà fare riferimento ad essa per l'emissione dell'ordine, fermo restando che, in ogni caso, i termini e le condizioni di fornitura specificati nell'offerta diventeranno vincolanti per il Venditore solo se e nei limiti in cui l'ordine venga successivamente confermato per iscritto dal medesimo.

3.4 Gli ordini e/o le modifiche di ordini effettuati verbalmente o telefonicamente devono essere confermati per iscritto dall'Acquirente che riceverà, a sua volta, la relativa conferma d'ordine da parte del Venditore. In caso contrario il Venditore non si assume alcuna responsabilità con riguardo a eventuali errori o possibili fraintendimenti.

3.5 I costi relativi ad eventuali modifiche o trasformazioni da eseguirsi sui Prodotti, laddove possibili, saranno a carico dell'Acquirente.

3.6 Laddove i contratti di compravendita prevedano più consegne nel tempo, il Venditore si riserva la facoltà di apportare ai Prodotti tutte le modifiche di natura estetica, dimensionale e tecnica che, nel rispetto delle relative caratteristiche funzionali e della normativa vigente, dovessero rendersi necessarie od opportune, senza che per ciò l'Acquirente possa avanzare pretese o reclami di alcun tipo.

### ART. 4 - PREZZI E PAGAMENTI

4.1 Salvo diversa pattuizione, i prezzi sono indicati in Euro, comprensivi di imballaggio, con esclusione di IVA, imposte indirette, tasse, accise, così come qualsivoglia imposta a carico dell'Acquirente che sarà corrisposta da quest'ultimo; in caso di esenzione, l'Acquirente fornirà al Venditore appropriata documentazione.

4.2 Il Venditore potrà in qualsiasi momento modificare i prezzi dei Prodotti in conseguenza dell'aumento di costi delle materie prime e della manodopera; tuttavia, i Prodotti non saranno consegnati ovvero offerti a prezzi aumentati senza previa comunicazione.

4.3 Salvo diversa pattuizione, i pagamenti saranno effettuati presso la sede del Venditore, nel rispetto dei termini e delle condizioni concordate; i termini di pagamento decorrono dalla data della fattura.

4.5 In caso di resi parziali concordati, la fornitura dovrà essere comunque pagata per intero. Ricevuto il pagamento da parte dell'Acquirente, il Venditore provvederà ad emettere nota di accredito sul reso ricevuto nel rispetto delle stesse condizioni e termini di pagamento concessi all'Acquirente nel contratto.

### ART. 5 - MANCATO O RITARDATO PAGAMENTO

5.1 Per nessuna ragione i pagamenti potranno essere ritardati e/o trattenuti; eventuali reclami o contestazioni non daranno diritto al rifiuto del pagamento ovvero ad eventuali compensazioni.

5.2 Fatti salvi tutti i diritti riconosciuti al Venditore, in caso di ritardo o difetto di pagamento entro i termini convenuti, o di rifiuto di presa in consegna dei Prodotti acquistati e senza pregiudizio all'esercizio dei diritti afferenti alla proprietà:

a) saranno applicati gli interessi di mora, ai sensi del decreto legislativo n. 231/2002, a decorrere dalla data in cui sia maturato il diritto al pagamento;

b) il Venditore potrà sospendere la consegna dei Prodotti così come interrompere la garanzia fino alla sua ripresa, senza pregiudizio sulla relativa data di scadenza nonché imputare le somme fino a quel momento ricevute ai debiti scaduti;

c) l'Acquirente decadrà dal beneficio del termine con diritto per il Venditore di pretendere il pagamento immediato del debito residuo.

### ART. 6 - TERMINI DI CONSEGNA

6.1 Se non diversamente concordato per iscritto, qualsiasi termine di consegna



indicato non sarà vincolante per il Venditore. Salvo diverso accordo tra le parti, il termine di consegna è indicativo ed è quello precisato nella conferma d'ordine.

6.2 Qualsiasi responsabilità inerente le consegne derivante da forza maggiore o da altri eventi imprevedibili - elencati a titolo esemplificativo, ma non esaustivo, nel successivo art. 12 - non imputabili al Venditore, liberano quest'ultimo dall'obbligo di rispettare il termine di consegna pattuito anche se vincolante.

6.3 Indipendentemente da quanto pattuito in ordine alla resa (porto franco o assegnato) o ai costi di trasporto e di assicurazione, la consegna ed il conseguente trasferimento dei rischi si considereranno intervenuti, in ogni caso ed a tutti gli effetti, con il caricamento della merce sul mezzo di trasporto alla partenza presso lo stabilimento del Venditore.

6.4 Qualora l'acquirente non provveda al ritiro dei Prodotti o ad accettarne la consegna, il Venditore avrà la facoltà, trascorsi 15 giorni dalla diffida ed impregiudicati i rimedi previsti dalla legge, di risolvere il contratto e di rivendere al meglio i Prodotti non ritirati, comunicando all'Acquirente i termini e le condizioni di vendita, trattenendo in via definitiva e a titolo di penale, l'acconto e le eventuali rate di prezzo già versati dal Cliente. La differenza tra il prezzo contrattuale (maggiorato delle spese di custodia e conservazione) e quello ricavato dalla rivendita a terzi costituirà debito del Cliente, su cui maturano gli interessi di mora nella misura indicata all'art. 5.2, lett. a). È fatto comunque salvo il diritto del Venditore al risarcimento del maggior danno eventualmente sofferto.

#### ART. 7 - RISERVA DI PROPRIETA' E TRASFERIMENTO DEI RISCHI

7.1 Il Venditore conserva la proprietà dei Prodotti fino al completo pagamento degli stessi ivi compresi i costi accessori.

7.2 Intervenuta la consegna, l'Acquirente sarà responsabile per tutti i danni che i Prodotti potranno subire o causare.

7.3 Fino a che non sia intervenuto il completo pagamento, i Prodotti non potranno essere rivenduti senza il previo consenso scritto del Venditore.

#### ART. 8 - TERMINI DI GARANZIA

8.1 I Prodotti sono fabbricati nel rispetto della normativa applicabile ed il Venditore offre garanzia per un periodo di 24 (ventiquattro) mesi dalla data di consegna.

8.2 Qualsivoglia vizio deve essere denunciato con le modalità previste dal successivo art. 14 entro 8 (otto) giorni dalla data di consegna. In caso di vizi occulti il termine di 8 (otto) giorni inizia a decorrere dal momento della loro scoperta.

8.3 Qualora l'Acquirente sia un "Consumatore", così come definito nell'art. 3 del Codice del Consumo (decreto legislativo n. 206/2005), la denuncia per l'eventuale difetto di conformità del Prodotto deve essere effettuata entro 2 (due) mesi dalla scoperta.

8.4 Il Venditore non è responsabile per qualsivoglia vizio dei Prodotti derivante da disegni, design o specifiche tecniche fornite dall'Acquirente, così come per i vizi derivanti da usura, inappropriato od inadatto magazzino o modalità d'uso, negligenza o imperizia, manomissione o alterazione dei Prodotti posti in essere dall'Acquirente o da terzi.

8.5 Il Venditore non è responsabile per danni o perdite di qualsiasi genere o natura occorsi alla totalità o parte dei Prodotti durante il trasporto, indipendentemente dal fatto che il trasporto si effettuato da un vettore incaricato da terzi, dall'Acquirente o dallo stesso Venditore, che in tale ultimo caso non assume nessuna garanzia in tal senso liberandosi dall'obbligo della consegna con la semplice rimessa al vettore.

8.6 Nel caso in cui un reclamo per difetti o vizi si riveli ben fondato, la garanzia sarà limitata alla sostituzione o alla riparazione dei Prodotti viziati o dei componenti difettosi con espressa esclusione di qualsivoglia risoluzione contrattuale, riduzione del prezzo, sospensione del pagamento o interruzione della garanzia. La sostituzione dei Prodotti difettosi sarà a discrezione del Venditore previa verifica presso i propri laboratori.

#### ART. 9 - LIMITAZIONE DELLA RESPONSABILITA'

9.1 Il Venditore non è responsabile per i danni diretti, indiretti e consequenziali senza limitazione alcuna, sofferti da cose o persone durante l'uso e/o la manutenzione dei Prodotti venduti. In tali casi l'Acquirente dovrà mantenere il Venditore esente ed immune da qualsivoglia eventuale domanda, azione, procedura e/o reclamo azionato da terzi danneggiati nei confronti del medesimo.

9.2 L'eventuale responsabilità del Venditore sarà, in ogni caso, limitata al costo dei prodotti difettosi che hanno dato origine a tale responsabilità così come quantificati dal prezzo netto fatturato all'Acquirente.

#### ART. 10 - DIRITTI DI PROPRIETA' INDUSTRIALE ED INTELLETTUALE

10.1 I marchi, brevetti, disegni, progetti, prototipi, segreti industriali, know-how così come qualsivoglia relativo diritto di proprietà industriale ed intellettuale sono di titolarità esclusiva di LEUCOS e rimangono di proprietà della stessa anche successivamente alla vendita dei Prodotti.

10.2 L'Acquirente per poter esporre i marchi e/o fregi del Venditore nell'ambito della sua attività deve ricevere per iscritto dal medesimo preventiva autorizzazione.

#### ART. 11 - RISOLUZIONE DEL CONTRATTO

11.1 Nel caso in cui l'Acquirente non effettui il pagamento entro il termine prescritto o si renda inadempiente in modo continuativo o grave senza porvi rimedio entro 30 (trenta) giorni lavorativi decorrenti dalla diffida inviata da LEUCOS, il Venditore potrà immediatamente risolvere il contratto, salvo ed impregiudicato ogni ulteriore diritto.

11.2 In ogni caso, LEUCOS potrà immediatamente risolvere il contratto, nel caso di dichiarazione di fallimento dell'Acquirente, liquidazione, sospensione dei pagamenti o pignoramento, insolvenza ovvero ogni altra situazione che possa incidere sull'adempimento dell'Acquirente.

#### ART. 12 - FORZA MAGGIORE

12.1 Se l'esecuzione del contratto o di ogni altra obbligazione (diversa dal pagamento) è ostacolata, limitata ovvero impedita da eventi di forza maggiore che persistano per più di 3 (tre) mesi, ciascuna parte potrà risolvere il contratto, senza responsabilità alcuna.

12.2 Per "Evento di forza maggiore" si intende ogni evento al di là del ragionevole controllo della parte interessata, inclusi, senza limitazione alcuna, sciopero, serrata, boicottaggio, guerra, insurrezione, guerra civile, atto vandalico, adeguamento a leggi o disposizioni governative, norme, regolamenti o direttive, incidente, guasto agli impianti o macchinari, incendio, inondazione, difficoltà, ovvero aumento dei costi della manodopera o dei trasporto nonché qualsivoglia altra circostanza in grado di compromettere la fornitura dei Prodotti.

12.3 La parte interessata informerà direttamente l'altra parte del verificarsi dell'evento di forza maggiore di cui abbia avuto conoscenza e che ritenga possa compromettere l'esecuzione del contratto.

#### ART. 13 - TRATTAMENTO DEI DATI PERSONALI

13.1 I dati personali dell'Acquirente saranno trattati secondo quanto disposto dalla legge italiana in materia di trattamento dei dati personali (decreto legislativo n. 196/2003). Il Venditore informa l'Acquirente che il Venditore è il titolare del trattamento e che i dati personali dell'Acquirente vengono raccolti e trattati esclusivamente per l'esecuzione del contratto.

13.2 Per qualsivoglia ulteriore informazione si fa riferimento all'informativa sulla privacy presente nel sito [www.leucos.com](http://www.leucos.com).

#### ART. 14 - COMUNICAZIONI

Fatta eccezione per le informazioni di carattere operativo, tutte le comunicazioni saranno trasmesse per iscritto, via fax, lettera raccomandata a/r o P.E.C. o corriere espresso a: LEUCOS, via del Commercio 22, 36060 Romano d'Ezzelino (VI) ITALY - PEC: [clannsr@legalmail.it](mailto:clannsr@legalmail.it)

#### ART. 15 - LEGGE APPLICABILE E FORO COMPETENTE

15.1 Le presenti Condizioni Generali di Vendita LEUCOS, così come ogni relativo contratto di compravendita ed ogni questione che trae origine dagli stessi ovvero connessa, sarà disciplinata, interpretata, eseguita e retta dalla legge ed i regolamenti italiani in vigore, con espressa esclusione della Convenzione di Vienna del 1980 relativa ai contratti di vendita internazionale di beni.

15.2 Qualsiasi controversia insorta tra le parti a seguito dell'interpretazione, validità o esecuzione delle presenti Condizioni Generali di Vendita LEUCOS e dei relativi contratti stipulati sarà devoluta alla competenza esclusiva del Tribunale di Venezia, ogni altro Foro escluso.

15.3 Resta inteso tra le parti che soltanto il Venditore, a propria discrezione, avrà la facoltà di rinunciare alla competenza del Foro esclusivo, di cui al punto 15.2 che precede, per agire in giudizio nei confronti dell'Acquirente, al suo domicilio e presso il Tribunale ivi competente.

#### ART. 16 - DISPOSIZIONI FINALI

16.1 Diritti e obblighi derivanti dalle presenti Condizioni Generali di Vendita LEUCOS e i relativi contratti di compravendita non potranno essere ceduti senza il previo consenso scritto del Venditore.

16.2 L'invalidità in tutto o in parte di singole disposizioni delle presenti Condizioni Generali di Vendita LEUCOS non inficia la validità delle restanti previsioni.

16.3 I diritti o rimedi di LEUCOS previsti dalle presenti Condizioni Generali di Vendita LEUCOS non pregiudicano qualsivoglia altro diritto o rimedio disposto dalla legge applicabile.

16.4 Il difetto o il ritardo da parte di LEUCOS nell'esercizio dei propri diritti non costituisce rinuncia o perdita di tale diritto.

16.5 La rubricazione degli articoli delle presenti Condizioni Generali LEUCOS in alcun modo potrà essere interpretata quale limitazione ovvero estensione della portata del contenuto della particolare sezione alla quale si riferisce.

16.6 Le presenti Condizioni Generali di Vendita LEUCOS sono redatte in duplice lingua italiana e inglese. In caso sorgessero dubbi interpretativi prevarrà la versione in italiano.

16.7 Le presenti Condizioni Generali di Vendita LEUCOS entrano in vigore dal 29 marzo 2019 e sostituiscono le precedenti.

16.8 In caso di giustificato motivo, i resi di merce dovranno comunque essere autorizzati per iscritto dall'ufficio commerciale del Venditore, che comunicherà le istruzioni cui attenersi.

Condizioni Generali di Vendita LEUCOS e i relativi contratti di compravendita non potranno essere ceduti senza il previo consenso scritto del Venditore.

16.9 L'invalidità in tutto o in parte di singole disposizioni delle presenti Condizioni Generali di Vendita LEUCOS non inficia la validità delle restanti previsioni.

Ai sensi e per gli effetti di cui agli articoli 1341 e 1342 del Codice Civile, l'Acquirente dichiara di approvare espressamente le seguenti clausole delle Condizioni Generali di Vendita LEUCOS: 1.3 (aspetti generali); 3 (conclusione del contratto); 6 (termini di consegna); 8.5 - 8.6 (termini di garanzia); 9 (limitazione della responsabilità); 15 (legge applicabile e foro competente); 16 (disposizioni finali).

LEUCOS code	GTIN (EAN code)	Product Name
		<b>JJ GREAT</b>
0011140	8052011013755	JJ GREAT - Floor Indoor - LED 1X45W - Matte white
0011141	8052011013762	JJ GREAT - Floor Indoor - LED 1X45W - Matte black
0011142	8052011013779	JJ GREAT - Floor Indoor - LED 1X45W - Amarant red
0011143	8052011013786	JJ GREAT - Floor Indoor - LED 1X45W - Mica blue
0011144	8052011013793	JJ GREAT - Floor Indoor - LED 1X45W - Sablè grey
0011145	8052011013809	JJ GREAT - Floor Indoor - LED 1X45W - Rust brown
0011150	8052011013816	JJ GREAT - Floor Indoor - LED 1X45W - CASAMBI - Matte White
0011151	8052011013823	JJ GREAT - Floor Indoor - LED 1X45W - CASAMBI - Matte black
0011152	8052011013830	JJ GREAT - Floor Indoor - LED 1X45W - CASAMBI - Amarant red
0011153	8052011013847	JJ GREAT - Floor Indoor - LED 1X45W - CASAMBI - Mica blue
0011154	8052011013854	JJ GREAT - Floor Indoor - LED 1X45W - CASAMBI - Sablè grey
0011155	8052011013861	JJ GREAT - Floor Indoor - LED 1X45W - CASAMBI - Rust brown
0011160	8052011013878	JJ GREAT - Floor Outdoor - LED 1X45W - CASAMBI - Matte white
0011161	8052011013885	JJ GREAT - Floor Outdoor - LED 1X45W - CASAMBI - Matte black
0011162	8052011013892	JJ GREAT - Floor Outdoor - LED 1X45W - CASAMBI - Amarant red
0011163	8052011013908	JJ GREAT - Floor Outdoor - LED 1X45W - CASAMBI - Mica blue
0011164	8052011013915	JJ GREAT - Floor Outdoor - LED 1X45W - CASAMBI - Sablè grey
0011165	8052011013922	JJ GREAT - Floor Outdoor - LED 1X45W - CASAMBI - Rust brown
0011170	8052011013939	JJ GREAT - Pendant - LED 1X45W - Push-dim, 0/1-10V, DALI - Matte white
0011171	8052011013946	JJ GREAT - Pendant - LED 1X45W - Push-dim, 0/1-10V, DALI - Matte black
0011281	8052011013953	JJ GREAT - Pendant - LED 1X45W - Push-dim, 0/1-10V, DALI - Amarant red
0011282	8052011013960	JJ GREAT - Pendant - LED 1X45W - Push-dim, 0/1-10V, DALI - Mica blue
0011283	8052011013977	JJ GREAT - Pendant - LED 1X45W - Push-dim, 0/1-10V, DALI - Sablè grey
0011284	8052011013984	JJ GREAT - Pendant - LED 1X45W - Push-dim, 0/1-10V, DALI - Rust brown
8000328	8052011013991	LED MODULE FOR JJ GREAT Floor, Pendant (indoor) 1x45W 6691lm 3000K
8000334	8052011014004	LED MODULE FOR JJ GREAT Floor, Pendant (indoor) 1x45W 6433lm 2700K
8000330	8052011014011	LED MODULE FOR JJ GREAT Floor (outdoor) 1x45W 6691lm 3000K
8000329	8052011014028	LED MODULE FOR JJ GREAT Floor (outdoor) 1x45W 6433lm 2700K
		<b>JJ BIG</b>
0011100	8052011013359	JJ BIG - Floor Indoor - LED 1X45W - Matte white
0011101	8052011013366	JJ BIG - Floor Indoor - LED 1X45W - Matte black
0011102	8052011013373	JJ BIG - Floor Indoor - LED 1X45W - Amarant red
0011103	8052011013380	JJ BIG - Floor Indoor - LED 1X45W - Mica blue
0011104	8052011013397	JJ BIG - Floor Indoor - LED 1X45W - Sablè grey
0011105	8052011013403	JJ BIG - Floor Indoor - LED 1X45W - Rust brown
0011110	8052011013410	JJ BIG - Floor Indoor - LED 1X45W - CASAMBI - Matte White
0011111	8052011013427	JJ BIG - Floor Indoor - LED 1X45W - CASAMBI - Matte black
0011112	8052011013434	JJ BIG - Floor Indoor - LED 1X45W - CASAMBI - Amarant red
0011113	8052011013441	JJ BIG - Floor Indoor - LED 1X45W - CASAMBI - Mica blue
0011114	8052011013458	JJ BIG - Floor Indoor - LED 1X45W - CASAMBI - Sablè grey
0011115	8052011013465	JJ BIG - Floor Indoor - LED 1X45W - CASAMBI - Rust brown
0011120	8052011013472	JJ BIG - Floor Outdoor - LED 1X45W - CASAMBI - Matte white
0011121	8052011013489	JJ BIG - Floor Outdoor - LED 1X45W - CASAMBI - Matte black
0011122	8052011013496	JJ BIG - Floor Outdoor - LED 1X45W - CASAMBI - Amarant red
0011123	8052011013502	JJ BIG - Floor Outdoor - LED 1X45W - CASAMBI - Mica blue
0011124	8052011013519	JJ BIG - Floor Outdoor - LED 1X45W - CASAMBI - Sablè grey
0011125	8052011013526	JJ BIG - Floor Outdoor - LED 1X45W - CASAMBI - Rust brown
0011130	8052011013533	JJ BIG - Pendant - LED 1X45W - Push-dim, 0/1-10V, DALI - Matte white
0011131	8052011013540	JJ BIG - Pendant - LED 1X45W - Push-dim, 0/1-10V, DALI - Matte black
0011285	8052011013557	JJ BIG - Pendant - LED 1X45W - Push-dim, 0/1-10V, DALI - Amarant red
0011286	8052011013564	JJ BIG - Pendant - LED 1X45W - Push-dim, 0/1-10V, DALI - Mica blue
0011287	8052011013571	JJ BIG - Pendant - LED 1X45W - Push-dim, 0/1-10V, DALI - Sablè grey
0011288	8052011013588	JJ BIG - Pendant - LED 1X45W - Push-dim, 0/1-10V, DALI - Rust brown
0011300	8052011013595	JJ BIG - Grip Indoor - LED 1X45W - Push-dim - Matte white
0011301	8052011013601	JJ BIG - Grip Indoor - LED 1X45W - Push-dim - Matte black
0011302	8052011013618	JJ BIG - Grip Indoor - LED 1X45W - Push-dim - Amarant red
0011303	8052011013625	JJ BIG - Grip Indoor - LED 1X45W - Push-dim - Mica blue
0011304	8052011013632	JJ BIG - Grip Indoor - LED 1X45W - Push-dim - Sablè grey
0011305	8052011013649	JJ BIG - Grip Indoor - LED 1X45W - Push-dim - Rust brown
0011310	8052011013656	JJ BIG - Grip Outdoor - LED 1X45W - CASAMBI - Matte white
0011311	8052011013663	JJ BIG - Grip Outdoor - LED 1X45W - CASAMBI - Matte black
0011312	8052011013670	JJ BIG - Grip Outdoor - LED 1X45W - CASAMBI - Amarant red
0011313	8052011013687	JJ BIG - Grip Outdoor - LED 1X45W - CASAMBI - Mica blue
0011314	8052011013694	JJ BIG - Grip Outdoor - LED 1X45W - CASAMBI - Sablè grey
0011315	8052011013700	JJ BIG - Grip Outdoor - LED 1X45W - CASAMBI - Rust brown
8000311	8052011013717	LED MODULE FOR JJ BIG Floor, Pendant and Grip (indoor) 1x45W 6691lm 3000K
8000310	8052011013724	LED MODULE FOR JJ BIG Floor, Pendant and Grip (indoor) 1x45W 6433lm 2700K
8000313	8052011013731	LED MODULE FOR JJ BIG Floor and Grip (outdoor) 1x45W 6691lm 3000K
8000312	8052011013748	LED MODULE FOR JJ BIG Floor and Grip (outdoor) 1x45W 6433lm 2700K
8000320	8052011011775	AUTOPOLE H 210 cm 370 cm
8000321	8052011011782	GRIP MOUNT Wall Ceiling L50cm
8000322	8052011011799	GRIP MOUNT Wall Ceiling L120cm



LEUCOS code GTIN (EAN code) Product Name

**JJ MID**

0011350	8052011010693	JJ MID Floor - E27 - Matte white
0011351	8052011010709	JJ MID Floor - E27 - Matte black
0011352	8052011010716	JJ MID Floor - E27 - Amarant red
0011353	8052011010723	JJ MID Floor - E27 - Mica blue
0011354	8052011010730	JJ MID Floor - E27 - Sablè grey
0011355	8052011010747	JJ MID Floor - E27 - Rust brown
0011340	8052011013212	JJ MID Floor - LED 1x13W - Matte white
0011341	8052011013229	JJ MID Floor - LED 1x13W - Matte black
0011342	8052011013236	JJ MID Floor - LED 1x13W - Amarant red
0011343	8052011013243	JJ MID Floor - LED 1x13W - Mica blue
0011344	8052011013250	JJ MID Floor - LED 1x13W - Sablè grey
0011345	8052011013267	JJ MID Floor - LED 1x13W - Rust brown
0011330	8052011010877	JJ MID Wall - E27 - Matte white
0011331	8052011010884	JJ MID Wall - E27 - matte black
0011332	8052011010891	JJ MID Wall - E27 - Amarant red
0011333	8052011010907	JJ MID Wall - E27 - Mica blue
0011334	8052011010914	JJ MID Wall - E27 - Sablè grey
0011335	8052011010921	JJ MID Wall - E27 - Rust brown
0011320	8052011013274	JJ MID Wall - LED 1x13W - Matte white
0011321	8052011013281	JJ MID Wall - LED 1x13W - matte black
0011322	8052011013298	JJ MID Wall - LED 1x13W - Amarant red
0011323	8052011013304	JJ MID Wall - LED 1x13W - Mica blue
0011324	8052011013311	JJ MID Wall - LED 1x13W - Sablè grey
0011325	8052011013328	JJ MID Wall - LED 1x13W - Rust brown
8000092	8052011010587	WALL BRACKET B LARGE - FOR JJ MID WALL - Matte white
8000094	8052011010594	WALL BRACKET B LARGE - FOR JJ MID WALL - Matte black
8000327	8052011013335	LED MODULE FOR JJ MID Floor and Wall - 1x13W 1600lm 3000K
8000325	8052011013342	LED MODULE FOR JJ MID Floor and Wall - 1x13W 1490lm 2700K

**JJ SMALL**

0011370	8052011013038	JJ SMALL - E27 - Matte white
0011371	8052011013045	JJ SMALL - E27 - Matte black
0011372	8052011013052	JJ SMALL - E27 - Amarant red
0011373	8052011013069	JJ SMALL - E27 - Mica blue
0011374	8052011013076	JJ SMALL - E27 - Sablè grey
0011375	8052011013083	JJ SMALL - E27 - Rust brown
0011360	8052011013090	JJ SMALL - LED 1x13W 1600lm 3000K - Matte white
0011361	8052011013106	JJ SMALL - LED 1x13W 1600lm 3000K - Matte black
0011362	8052011013113	JJ SMALL - LED 1x13W 1600lm 3000K - Amarant red
0011363	8052011013120	JJ SMALL - LED 1x13W 1600lm 3000K - Mica blue
0011364	8052011013137	JJ SMALL - LED 1x13W 1600lm 3000K - Sablè grey
0011365	8052011013144	JJ SMALL - LED 1x13W 1600lm 3000K - Rust brown
0012078	8052011013151	JJ SMALL - LED 1x13W 1490lm 2700K - Matte white
0012079	8052011013168	JJ SMALL - LED 1x13W 1490lm 2700K - Matte black
0012080	8052011013175	JJ SMALL - LED 1x13W 1490lm 2700K - Amarant red
0012081	8052011013182	JJ SMALL - LED 1x13W 1490lm 2700K - Mica blue
0012082	8052011013199	JJ SMALL - LED 1x13W 1490lm 2700K - Sablè grey
0012083	8052011013205	JJ SMALL - LED 1x13W 1490lm 2700K - Rust brown
8000301	8052011010549	ACCESSORY FOR JJ SMALL - TABLE BRACKET A-AX - H max 5,5cm
8000303	8052011010556	ACCESSORY FOR JJ SMALL - TABLE BRACKET A-AX - H max 5,5cm
8000088	8052011010563	ACCESSORY FOR JJ SMALL - TABLE BRACKET A LUNGO - H max 9,5cm
8000090	8052011010570	ACCESSORY FOR JJ SMALL - TABLE BRACKET A LUNGO - H max 9,5cm
8000092	8052011010587	ACCESSORY FOR JJ SMALL - WALL BRACKET B LARGE - Matte white
8000094	8052011010594	ACCESSORY FOR JJ SMALL - WALL BRACKET B LARGE - Matte black
8000095	8052011010600	ACCESSORY FOR JJ SMALL - FIXED TABLE C BRACKET EXTERNAL - Matte white
8000097	8052011010617	ACCESSORY FOR JJ SMALL - FIXED TABLE C BRACKET EXTERNAL - Matte black
8000098	8052011010624	ACCESSORY FOR JJ SMALL - FIXED TABLE P BRACKET INTERNAL - Matte black
8000078	8052011010631	ACCESSORY FOR JJ SMALL - ROUND BASE - Matte white
8000080	8052011010648	ACCESSORY FOR JJ SMALL - ROUND BASE - Matte black
8000335	8052011010655	ACCESSORY FOR JJ SMALL - ROUND BASE - Amarant red
8000331	8052011010662	ACCESSORY FOR JJ SMALL - ROUND BASE - Mica blue
8000332	8052011010679	ACCESSORY FOR JJ SMALL - ROUND BASE - Sablè grey
8000333	8052011010686	ACCESSORY FOR JJ SMALL - ROUND BASE - Rust brown



---

COPYRIGHT  
Leucos

EDITION  
February 2023



The list prices are inclusive of the charges introduced by the law by decree dated 25th July 2005, n. 151 (Regulations 2002/95/CE, 2002/96/CE e 2003/108/CE relative to the use reduction of dangerous substances in the electrical and electronic equipment (AEE) as well as to the waste disposal). WEEE: Waste of electrical and electronic equipment.

*I prezzi indicati nel presente listino sono inclusi da oneri introdotti dal decreto legislativo 25 luglio 2005, n. 151 (attuazione delle direttive 2002/95/CE, 2002/96/CE e 2003/108/CE, relative alla riduzione dell'uso di sostanze pericolose nelle apparecchiature elettriche ed elettroniche (AEE), nonché allo smaltimento dei rifiuti). RAEE: Rifiuti di apparecchi elettrici ed elettronici = WEEE: Waste of electrical and electronic equipment.*

According to the Commission Regulation (UE) N. 874/2012, from 1st march 2014 energy consumption labels are available at [www.leucos.com](http://www.leucos.com)

*In base al Regolamento Delegato (UE) N. 874/2012, dal 1 marzo 2014 sono disponibili le etichette indicanti il consumo energetico al sito [www.leucos.com](http://www.leucos.com)*

LEUCOS

Via del Commercio 22,  
36060 Romano d'Ezzelino  
(Vicenza) Italy

Phone +39 041 5741111  
Email [info.it@leucos.com](mailto:info.it@leucos.com)

LEUCOS USA Inc.

11 Mayfield Avenue  
Edison New Jersey, 08837  
United States of America

Phone 001 732 225-0010  
Email [info.us@leucos.com](mailto:info.us@leucos.com)

